Thank you for choosing SAIC MAXUS Automotive Co.,Ltd. May our products and services bring fresh joy to your life!

Please take time to read and understand this Handbook and other publications supplied with it. Thus you can familiarize yourself with the vehicle and enjoy a driving experience with comfort, safety as well as economy.

This Driver's Handbook will provide you with the information necessary for getting familiar with your vehicle, including how to drive the vehicle, how to carry out routine maintenance checks, and what to do in an emergency.

This Handbook contains the latest information upon the time of printing and all modifications, interpretations and explanations should be reserved by the company. Based on the consideration that the products will be upgraded or in any other way(s) modified constantly, the company reserves the right to apply these changes mentioned here before without notice when the Handbook has been hereby printed and published and will accept no liability.

This Handbook is an indispensable part of the vehicle. If you want to sell the vehicle, please remember to provide the new owner with this Handbook.

Special Announcement

Driver's Handbook and Warranty & Service Handbook specify the agreement between the company and the user on establishment and termination of rights and obligations concerning the quality warranty and after-sales service of product. Please be sure to read the Driver's Handbook and Warranty & Service Handbook carefully before using the product. If any damage is caused by misuse, neglect, incorrect operation or unauthorized refit, the user will have no right of claim, and any warranty request will be refused by SAIC MAXUS Automotive Co.,Ltd Service Dealer(hereinafter referred to as "Service Dealer").

Unauthorized re-production of this Handbook, whether electrically, physically or in any other way, and/or storing the Handbook in any inquiry system of any form or type shall not be permitted.

Wish you a pleasant driving!

SAIC MAXUS Automotive Co.,Ltd. Address: #2500, Jun Gong Road, Yang Pu District, Shanghai Postcode: 200438

SAIC MAXUS Automotive Co.,Ltd reserves the final right to interpret this Handbook

Contents

Perface	1	Manual tailgate	20
Introduction	1	Power tailgate	21
About this handbook	1	Child safety lock	26
Precautions	2	Windows	27
Dangerous substances.....	2	Power windows	27
Children/Animals	2	Power sunroof	29
Personal safety.....	2	Seats	32
Vehicle identification	3	Driver seat adjustment	32
Vehicle identification number (VIN)	3	Front occupant seat adjustment	37
Model and number of drive motor	3	2nd row seat adjustment	38
VIN plate.....	4	3rd row seat adjustment	49
Instructions for using electric vehicle	5	Headrest.....	53
Ambient temperature for vehicle use.....	5	Occupant restraint system	53
Driving range	5	Sitting correctly	53
Equalization charging	6	Seat belts	54
Instructions for recycling of high voltage battery packs	6	Seat belt pretensioner	59
High-voltage system	7	Airbag(s).....	60
Instructions when accident occurs	8	Child Restraints (not available with the vehicle).....	69
1 Before You Drive	9	Instruments and controls	78
Keys	10	Instrument cluster	79
Remote key with PEPS	10	Voltmeter of high-voltage battery pack	79
Extension/retraction of mechanical key portion of the remote key ("mechanical key portion" for short).....	10	Speedometer.....	80
Replace the battery in the remote key with PEPS.....	11	Power meter	80
Door locks	12	Message center.....	80
To protect your vehicle against theft.....	12	Alarm messages.....	83
Central door locking system.....	13	Service interface reminders.....	84
Manual side load door(s).....	16	Tire pressure monitoring system	85
Electric side load door(s).....	17	Warning lights and indicators	85
		Direction indicator.....	85

Contents

Headlight high beam indicator.....	85	ICA (Integrated Cruise Assist) indicators	91
IHC (Intelligent High Beam Control) indicator	85	SLIF (Speed Limit Information Function) indicators	92
Rear fog light indicator	86	ISA (Intelligent Speed Limit Assist) indicators.....	92
Position light indicator	86	ECO indicator.....	92
IMMO warning light	86	SPORT indicator	92
TPMS warning light	86	Speed limit indicator	92
Battery charging indicator.....	86	Trailer indicator.....	92
READY indicator	86	Exterior light switch.....	93
Charging connection indicator.....	86	Combination light control switch.....	93
Charging status indicator.....	87	AFS (Adaptive Front Lighting System)	94
Power system fault warning light.....	87	Hazard warning light switch.....	95
Warning light of high-voltage battery pack for low electric quantity.....	87	SOS E-call system switch.....	95
Insulation fault warning light.....	87	Switches on steering column and steering wheel	96
Power-limit Indicator	87	Wiper and washer lever switches	96
Airbag warning light.....	87	High beam, turn signal lever switch.....	98
Seat belt warning light	88	Instrument cluster selection and cruise switch	99
Brake system warning light	89	Voice control, Bluetooth telephone and custom settings switch.....	100
ABS (Anti-lock Braking System) warning light.....	89	Horn.....	101
EBD (Electronic Brake Distribution) warning light	89	Steering wheel adjustment.....	102
ESC (Electronic Stability Control) indicator	89	Heating, ventilation and air conditioning (HVAC).....	102
ESC (Electronic Stability Control) OFF indicator.....	89	Front vents	103
EPB (Electronic Parking Brake) indicator.....	89	Rear vents.....	104
EPB (Electronic Parking Brake) malfunction indicator	89	Front A/C control switch	104
AUTO HOLD indicator.....	90	A/C operation and display interfaces on center console screen.....	106
HDC (Hill Descent Control) indicator.....	90	Rear A/C control panel.....	110
EPS (Electric Power Steering) system malfunction warning light.....	90	Air conditioning operating tips	111
FCW (Forward Collision Warning) warning light/AEB (Automatic Emergency Braking) warning light.....	90	Rearview mirrors	112
LDW (Lane Departure Warning)/LKA (Lane Keep Assist) /ELK (Emergency Lane Keeping) warning light.....	91	Exterior rearview mirrors	112
ACC (Adaptive Cruise Control) indicators.....	91	Interior rearview mirrors	114

Contents

Interior equipment	117	Gear shift	138
Roof vanity light.....	117	Gear position.....	138
Trunk light.....	118	Shifting operation	139
Stepwell light	119	Charging requirement	141
Multi-color atmosphere light	119	Requirements for charging equipment	142
USB port.....	120	Safety instructions for charging with residential electricity	142
12V power socket.....	122	Requirements for charging environment	144
Wireless charging system for mobile phone.....	123	Influence of charging operation on special personnel.....	144
Vehicle inverter.....	124	Charging mode.....	145
Glove box	126	Fast charging.....	146
Storage box	126	Slow charging.....	148
Sun visor and vanity mirror.....	128	Charging information	153
Fire extinguisher	128	Equalizing charge.....	153
Vehicle tools	130	Charging time	153
Entertainment system	130	Low speed alarm module	154
2 Starting and Driving	133	Electric power steering system	155
Before Starting and Driving	134	Braking system	156
Start/stop vehicle	134	Service brake	156
Power on vehicle	134	ABS (Anti-lock Braking System).....	158
Start vehicle.....	134	ESC (Electronic Stability Control).....	159
Power off vehicle	134	EPB (Electrical Parking Brake).....	161
Automatic power off.....	135	AUTO HOLD	163
Emergency power off	135	HDC (Hill Descent Control)	164
PEPS system	135	Warning lights.....	165
Keyless unlocking.....	135	Brake pedal sensing mode switching function	165
Keyless locking.....	136	Parking assist system	165
Keyless start.....	136	Parking sensor	165
Backup starting.....	136	Front and rear sensors	167
Driving	137	Rear view camera	168
		360° around-view system.....	169

Contents

540° around-view system	170	Emergency Door Opening or Closing	212
Driver assistance system	171	Manually unlock and lock the driver door	212
Camera	171	Manually lock the front occupant door and rear doors	212
Radar	173	Manually unlock the tailgate	213
FCW and AEB (Forward collision assist)	175	Hazard warning light.....	214
LDW (Lane Departure Warning).....	177	Warning triangle	214
LKA (Lane Keeping Assist)	179	Self tire repair	215
ELK (Emergency Lane Keeping).....	181	Usage	217
ACC (Adaptive Cruise Control)	183	Towing a vehicle	221
ICA (Integrated Cruise Assist).....	186	Towing hitch.....	221
RCW (Rear Collision Warning).....	190	Towing	223
Rear collision assist.....	191	Jump start.....	224
SLIF (Speed Limit Information Function).....	192	Battery disconnection	224
ISA (Intelligent Speed Assistance)	194	Jump start.....	225
IHC (Intelligent Headlight Control).....	195	Fuse replacement	226
Blind spot assist	197	Driver compartment fuse box	226
RCTA (Rear Cross Traffic Alert)	199	Front compartment fuse box	229
DOW (Door Opening Warning)	200	Battery fuse box	232
Driver status monitor system	202	Fuse replacement.....	233
Tires	204	4 Maintenance and Service.....	235
Winter tires	205	Regular maintenance.....	236
Anti-skid chain	206	Owner's check	236
Loading	206	Daily checks	236
Trailer towing	207	Weekly checks or check before a long journey	236
Instructions of trailer towing.....	207	Harsh conditions.....	237
Recommended towing weight	209	Engine hood.....	237
Trailer electrical interface	210	Open front compartment hood	237
Maintenance.....	210	Close front compartment hood	238
3 Emergency Troubleshooting	211		

Contents

Engine compartment	239	Vehicle wash	253
Coolant	239	Anti-corrosion of underbody	254
Check and refill.....	240	Seat and trim.....	254
Brake fluid	241	Door seals	254
Check and refill.....	242	Window glass	254
Washer fluid	242	5 General Technical Parameters	255
Check and refill.....	242	Major vehicle dimension parameters	256
Wiper blades	243	Vehicle weight parameters	257
Inspection	243	Dynamic performance parameters	258
Replacement of front windshield wiper blade.....	243	Main parameters of drive motor	259
Replacement of rear windshield wiper blade.....	244	Chassis technical parameters	260
Maintenance and service	244	Recommended fluids	261
Seat belts	245	Wheels and tires	262
Inspection	245	Wheel alignment parameters	263
Maintenance and service	245		
Battery	246		
Duration of storing the vehicle.....	247		
Operating in winter	247		
Charging the battery with ground equipment	247		
Removing the battery	248		
Replacing the battery	248		
Installing the battery	249		
High voltage battery pack	249		
Instructions and restricted conditions	249		
Tires	251		
Tire pressure	251		
Wear indicator	252		
Tire check and rotation.....	252		
Other maintenance	253		

Preface

Introduction

About this handbook

This manual applies to MIFA 9 series multi-purpose pure electric passenger vehicles.

Caution

IMPORTANT: The information contained in this Handbook is designed to cover more than one model option and variant, and therefore some of the items mentioned here may not apply to your vehicle.

The applicable executive enterprise standard is Q31/0110000019C003.

The drawings contained in this Handbook are illustrations for references only.

Indicative information

Warning



This symbol indicates that: In order to avoid the possibility of personal injury or injury to others, relevant procedures must be followed strictly and precisely.

Caution

Caution

Relevant procedures must be followed to avoid the possibility of vehicle damage.

Note

Note: *This is suggestive description which is useful for you.*

Environmental protection



Everyone is obliged to protect the environment. This symbol intends to remind you to pay attention to environmental protection.

Arrows



It represents the described object.



It represents its direction of motion.

See

The contents are referred by the "Section" title.

Preface

Precautions

Dangerous substances

 Many liquids and other substances used in motor vehicles are poisonous and should under no circumstances be consumed and should, so far as possible, be kept away from open wounds. These substances among others include battery acid, coolant, brake fluid, washer fluid, lubricants, refrigerant and various adhesives. Always read carefully the instructions printed on the labels or stamped on components and obey them implicitly. These instructions are for the sake of your health and personal safety. Please treat them with prudence.

For your safety, observe instructions contained in this Handbook.

Children/Animals

 Accidents and injury may be caused by unsupervised children or animals operating controls and switches fitted to your vehicle, or playing with equipment or goods being transported in it.

In order to prevent the accident or personal injury caused by a child or animal, do not leave the child or animal in the vehicle without adult supervision. Also they can become suffocated in hot weather conditions.

Personal safety

 Seat belts are fitted to all seats in your vehicle to reduce the possibility of personal injury in the event of an accident. It is required that all passengers wear a seat belt. In addition, your vehicle has been installed with supplementary restraint system (SRS) comprising an airbag and a seat belt pre-tensioner, providing extra protection for the driver and front passenger.

Please see “Occupant restraint system” in Before You Drive section. Misuse of an air bag can result in injury.

Vehicle identification

When communicating with our authorized service provider, you should provide the vehicle identification number.

Vehicle identification number (VIN)

Vehicle identification number (VIN) on the vehicle:

- Under the right front seat of the vehicle, on the cross member of seat (Stamp position).
- On the VIN plate on the left B pillar.
- On the windshield lower cross member at the right lower corner of the windshield through where the VIN can be seen easily.
- On the left fender (if equipped).
- On the rear anti-collision beam outer panel assembly (if equipped).
- At the upper panel of tailgate inner panel (if equipped).
- On the bonnet inner panel (if equipped).
- On the left inside wall of glove box (if equipped).
- On the transmission body (if equipped).

This vehicle is equipped with an OBD data link connector, which is located at the lower side of the right instrument cluster. You can contact our authorized service provider to read VIN information from the electronic control unit of the vehicle with the special device from our company.

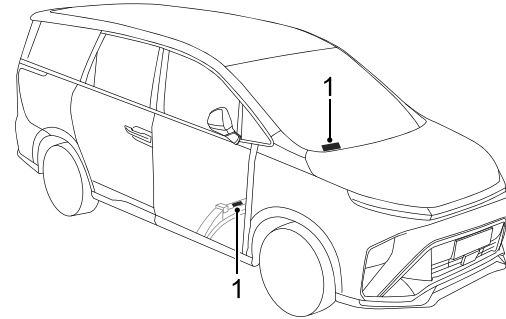

1 Vehicle identification number (VIN)

Model and number of drive motor

The model and number of drive motor are carved on the housing of the drive motor.

Preface

VIN plate

VIN plate may contain the following information:

- VIN
- Brand
- Vehicle model
- Model of drive motor
- Peak power of drive motor
- Maximum allowable total mass
- Rated voltage of power battery system
- Rated capacity of power battery system
- Built date
- Country of manufacture
- Manufacturer
- Seat No.
- Curb weight of a vehicle

Location of VIN plate

VIN plate (1) is located at front lower side of left B pillar.

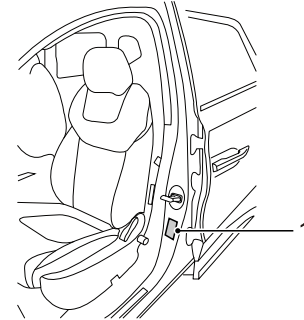

Instructions for using electric vehicle

Ambient temperature for vehicle use

The working performance of the high voltage battery pack in the power system of the vehicle is related to ambient temperature, so it is recommended to use the vehicle at the ambient temperature from -15°C to 45°C, to ensure the vehicle in the best working status and extend the life of the high-voltage battery pack. High or low temperature will affect the performance of the high-voltage battery pack and the vehicle. The working temperature range of the power battery is -30°C to 60°C, and the battery cannot work normally beyond the working temperature range. In the cold weather, it is recommended to store the vehicle in a warm house or park it nearby the charging pile for heating the battery by the connector before use, to avoid affecting traveling.

Driving range

The driving range depends on the available battery level, vehicle age (current battery life), weather, temperature, road conditions, driving habits, etc. Please note:

- The driving range is related to the discharging depth. To avoid affecting the performance of the high voltage battery pack due to high discharging depth, it is recommended that you promptly charge the vehicle after the high voltage battery pack battery level low warning lamp on the instrument cluster in the vehicle gives an alarm.
- The actual driving range of the vehicle is reduced with the increase of the vehicle age.
- The use of A/C will reduce the driving range.
- At different vehicle speeds, the driving ranges are different.
- During the vehicle use at low temperature, the driving range may be reduced due to the temperature characteristics of the battery.
- At extreme temperature and low battery level, the powerless acceleration and power insufficient may occur due to the battery characteristics. The vehicle driving range may be increased by the following methods:
 - Regularly maintain the vehicle.
 - Keep appropriate tire pressure.
 - Minimize the use of the vehicle under high and cold temperature.
 - After using the vehicle in the winter, do not park the vehicle for a long time, and charge it as soon as possible.
 - Remove unnecessary objects to reduce the vehicle load.
 - If necessary, turn off the A/C and other high-power electrical appliances or adjust the heating or cooling temperature to reduce the energy consumed by the high-power electrical appliances and increase the driving range.
 - At high vehicle speed, close the vehicle windows to reduce the air resistance and electricity consumption.

Preface

- Keep the vehicle speed steady.
- In acceleration, step on the accelerator pedal as gently as possible.
- In deceleration, release the accelerator pedal, do not step or gently step the brake pedal, then the energy recycling system will increase the driving range of your vehicle as much as possible.

The standard or dynamic driving range modes may be changed by using the switch on the central control screen, with different values of the driving range, and the latter varies according to your driving habits.

Equalization charging

To extend the life of the high voltage battery pack, regularly use the equalization charging method to maintain the high voltage battery pack. It is recommended to use the vehicle at least once every month. It is recommended to slowly charge the vehicle for more than 10 hours every month to extend the life of the high voltage battery pack.

Instructions for recycling of high voltage battery packs

The high voltage battery pack is installed at the position of motor-vehicle chassis. It contains many lithium battery cells. Arbitrary disposal may cause pollution and hazard to the environment. It is prohibited to disassemble and discard without approval. It will be disposed by professional institution. Be sure to dispose of according to the following information or requirements. Details about recycling and disposal of high voltage battery packs can be obtained through consulting our authorized service provider.

- Requirements for personnel: be disassembled by the professional personnel with qualifications.
- High voltage safety: make the insulation safety protection before uncovering or disassembling because the battery pack contains the lithium battery pack, high voltage harness, and other high voltage components.
- Transportation: the high voltage pack is the class 9 dangerous goods and must be transported by the vehicle with the class 9 dangerous goods transportation qualifications.
- Storage: the removed high voltage pack shall be stored in a normal temperature and dry environment and kept away from inflammables, heat sources, and water.
- Internal composition: the high voltage pack is composed of lithium battery (pack), circuit board, wires, metal case, and other components.

Preface

It is recommended that you deliver the waste high voltage battery pack produced due to vehicle scrap or other reasons to our designated recycling services for disposal. Details about maintenance, recycling and disposal of high voltage battery packs can be obtained through consulting our authorized service provider.

Note: The waste high voltage battery pack shall be delivered to other organizations or individuals. If environmental pollution or an safety accident results from the high voltage battery pack removed and disassembled without permission, the owner of the high voltage battery pack shall take the corresponding responsibilities.

High-voltage system



High-voltage system on vehicle includes AC and DC high voltage power (can reach over 460V). High-voltage power is very dangerous and may cause serious injury such as burning, electric shock and even death.

- It is prohibited to contact high-voltage cables and its connectors to avoid personal injury.
- Parts with orange labels are parts of high-voltage system. These parts are equipped with warning label of high-voltage system. Requirements on warning label of high-voltage system must be abided by.
- It is prohibited that non-professional repair personnel contact, disassemble or install any components of high-voltage system without approval.

Instructions when accident occurs



- Keep the vehicle at P gear, turn off the ignition switch.
- If cables on the vehicle are exposed or damaged, it is prohibited to contact any cable to prevent electric shock.
- In case of fire, personnel shall immediately leave the vehicle and use ammonium carbonate salt fire extinguisher to put out the fire or use lots of water to put out the fire. It is strictly prohibited that any person contacts or enters the burning vehicle during the rescue period. After fire has been put out, continuous observation is required. Professional personnel will remove the vehicle to spacious area after confirming power battery does not have abnormal sound and smoke. Professional personnel will confirm battery state before vehicle transfer.
- If the vehicle is collided, the vehicle shall not be re-started. In addition, the negative battery cable will be disconnected when rescuing.
- When vehicle is completely or partially immersed into water, personnel will turn off the vehicle and timely escape. The negative battery cable will be disconnected before transporting vehicle that has been refloated. If there is not bubble or abnormal sound when refloating, refloating operation can

be conducted; if there is bubble or abnormal sound, operation can be conducted when there is not bubble or abnormal sound.

- After accident has been disposed, please contact our authorized service provider.

Before You Drive

- 10 Keys
 - 12 Door locks
 - 27 Windows
 - 32 Seats
 - 53 Occupant restraint system
 - 78 Instruments and controls
 - 79 Instrument cluster
 - 85 Warning lights and indicators
 - 93 Exterior light switch
 - 95 SOS E-call system switch
 - 96 Switches on steering column and steering wheel
 - 102 Heating, ventilation and air conditioning (HVAC)
 - 112 Rearview mirrors
 - 117 Interior equipment
 - 130 Entertainment system
-

Before You Drive

Keys

The vehicle is equipped 2 remote keys with passive entry passive start system (hereinafter referred to as PEPS).

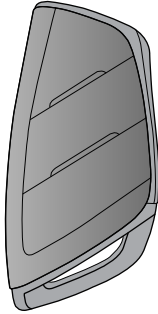

Note: *If a key is lost, you must provide the key number on the metal or plastic plate attached with the key, and the Our Service Dealer will provide the replacement. To ensure safety, you are recommended to keep the metal or plastic plate attached with key properly.*

Note: *For the sake of safety, the key has been electronically coded with the immobilizer system and can be used with the system in the matching way only. Special procedures shall be followed to manufacture a same key with the lost one. Any uncoded key cannot start the vehicle but can lock/unlock doors.*

Remote key with PEPS

The remote key is a control component of central door locking system of a vehicle, which can be used for locking/unlocking all doors.

Note: *The remote key has been electronically coded with the locking/unlocking system and can be used with the system in the matching way only. Special procedures shall be followed to manufacture a same remote key with the lost one. Our Service Dealer will be pleased to assist you.*

See "Central door locking system" in this section for more details about the remote key.

Caution

The immobilizer system can accept 4 coded keys at most (for remote keys with PEPS).

Extension/retraction of mechanical key portion of the remote key ("mechanical key portion" for short)

Press the release button on the remote key with PEPS, and pull the mechanical key portion from the key body.

To retract the mechanical key portion, directly insert it into the body of remote key with PEPS.

Before You Drive

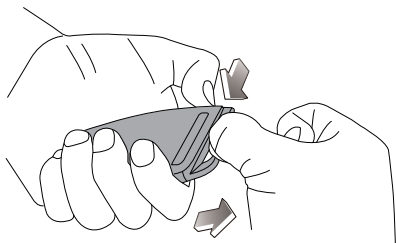

Replace the battery in the remote key with PEPS

! Batteries may present the risk of fire, explosion and burning. Never charge the battery. Properly dispose the used battery. Keep the battery out of reach of children.

! **WARNING:** Do not ingest the battery, chemical Burn Hazard.

This product contains coin/button cell battery. If the coin/button cell battery is swallowed, it can cause severe internal burns in just 2 hours and can lead to death. Keep new and used batteries away from children. If the battery compartment does not close securely, stop using the product and keep it away from children. If you think batteries might have been swallowed or placed inside any part of the body, seek immediate medical attention.

WARNING



To replace the battery, following procedures must be observed:

- 1 Press the release button on the remote key with PEPS.
- 2 Pull the mechanical key portion out of the key body.
- 3 Pry off the upper and lower panels of the body; the circuit board may fall off from the upper panel assembly when prying off them, and reinstall them.

Caution

Do not damage the circuit board when prying off the upper and lower panels.

- 4 Remove the used battery from the lower panel assembly and install a new one.

Note: *It is recommended to use a CR2032 battery.*

Caution

Pay attention to the positive and negative electrodes of battery.

Before You Drive

- 5 Refit the upper and lower panels of the battery body, and press their circumference to ensure they are clamped in place.

Caution

Do not ignore the waterproof shim and circuit board onto the upper panel of the key body.

- 6 Press the mechanical key portion into the key body.

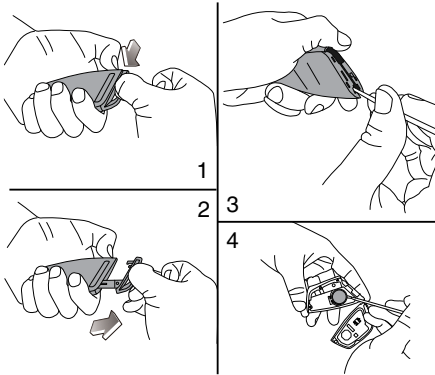

Caution

It is complicated to replace the battery in the remote key with PEPS. In order to prevent the key from being damaged due to misassembly or misoperation, you are recommended to have the battery replaced by Our Service Dealer.

Door locks

To protect your vehicle against theft

! When leaving the vehicle with occupants inside, even briefly, always carry the key and power off the vehicle, particularly if children are left in the vehicle. They could otherwise start the vehicle or operate electrical equipment at the risk of causing an accident.

Close all windows before leaving the vehicle.

Ensure all doors and hood are fully closed before locking.

Lock/unlock

You may lock/unlock all doors from outside by using the remote key with PEPS.

All doors can be locked/unlocked from the inside using central lock switch. All doors can be automatically locked according to the vehicle speed. See "Central door locking system" in this section.

Note: When all doors are successfully locked by using the remote key with PEPS, all turn signals will flash once, and the horn will sound once to indicate successful locking. When all doors are successfully unlocked with the remote key, all turn signals will flash twice to indicate successful unlocking.

Central door locking system

Using the mechanical key portion

All doors can be locked/unlocked by manually locking/unlocking the driver door using the mechanical key portion from the outside.

To lock, turn the mechanical key portion counterclockwise.

To unlock, turn the mechanical key portion clockwise.

Using the remote key with PEPS

All doors can be locked/unlocked through the central door locking system using the buttons on the remote key with PEPS.

Note: All doors must be fully closed for the system to operate correctly.

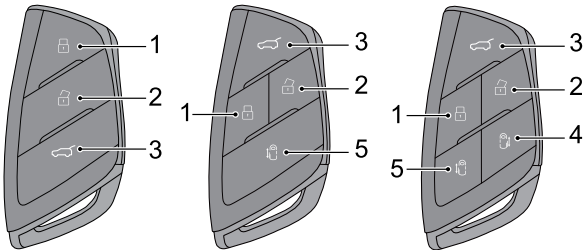

- 1 Central locking button (short press)/window up (long press)/panoramic sunroof closing (long press)

Note: For the functions of window up (long press) and sunroof closing (long press), please refer to your vehicle's actual configuration.

- 2 Central unlocking button (short press)/window down (long press)/panoramic sunroof opening (long press) button

Note: For the functions of window down (long press) and panoramic sunroof opening (long press), please refer to your vehicle's actual configuration.

- 3 Manual tailgate unlocking button/power tailgate unlocking and locking buttons
- 4 Right electric side load door opening/closing button
- 5 Left electric side load door opening/closing button

Caution
When locking with the LOCK button  on the remote key with PEPS, if there is another legal remote key with PEPS in the vehicle, then the latter key will be disabled, and the passive entry and one touch start feature will be lost. To activate it: close all doors, operate the unlocking button on the remote key with PEPS in a normal manner, the key shielded inside the vehicle will be activated.



All doors locking

Short press the button  to lock all doors, provided that all doors have been closed.

Before You Drive

Note: All turn signals flashing once represents the confirmation for locking; if any door or hood is not fully closed, there will be no audible alarm, please press the button .

Panoramic sunroof closing

Keep pressing  after locking; if the panoramic sunroof is open, the panoramic sunroof glass will automatically close. The maximum time for long press is 15 seconds. If the sunroof glass and guide rail suffer from snow or dirt, they should be cleaned immediately before long pressing .

Note: For the function of panoramic sunroof closing by long pressing , please refer to your vehicle's actual configuration.

All doors unlocking

Short press the button  to unlock all doors.

Note: If no door is opened within 30 seconds, all doors will be automatically locked again.



Panoramic sunroof opening

Keep pressing  after unlocking; if the panoramic sunroof is closed, the sunshade will be opened to the half-open position first, and then the panoramic sunroof glass will be opened to a comfortable position. The maximum time for long press is 15 seconds.





Note: For the function of panoramic sunroof opening by long pressing , please refer to your vehicle's actual configuration.

Tailgate button



Short press the button  to unlock the tailgate.

For vehicles equipped with power tailgate, long press the button  on the remote key with PEPS to open and close the power tailgate. During opening and closing, short press the button  to stop the tailgate movement, and long press the button  again to reverse the tailgate movement.



Right electric side load door opening/closing button

After the vehicle is unlocked, when the right electric side load door is closed, long press the button  to open the right side load door; during opening, short press the button  to stop operation of the right side load door; when the right electric side load door is open, long press the button  to close the right side load door; during closing, short press the button  to stop operation of the side load door.

Left electric side load door opening/closing button

After the vehicle is unlocked, when the left electric side load door is closed, long press the button  to open the left side load door; during opening, short press the button  to stop operation of the side load door; when the left electric side load door is open, long

Before You Drive

press the button  to close the left side load door; during closing, short press the button  to stop operation of the side load door.

Using the micro switch

PEPS system allows you to lock or unlock the doors without taking the remote key with PEPS out of your pocket, wallet, or suitcase.

Unlock with the remote key with PEPS

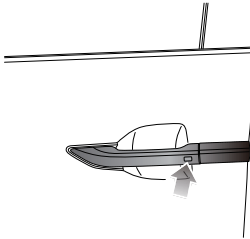

As long as there is a legitimate remote key with PEPS existing within 1 meter around the vehicle, press the micro switch on the door handle, and the door will be unlocked.

Lock with the remote key with PEPS



After powering off, leaving the vehicle and closing the door, touch the micro switch on the door handle with your thumb to lock the door, without pressing the lock button on the remote key with PEPS.

Using the central lock switch

All doors can be unlocked or locked from the inside using the switch. Press the locking button  to lock all doors. Press the unlocking button  to unlock all doors.

Note: If driver door is not closed, the lock motor will not operate. If any other door is not closed, the lock motor will operate.

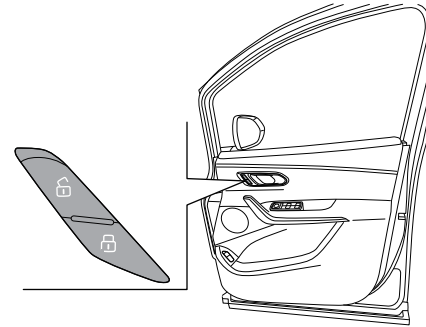

The door can also be unlocked by pulling the inner handle twice.

Note: During the driving, all doors shall be fully closed and all door locks shall be enabled, so as to avoid accidental opening of doors.

Before You Drive

Locking according to the vehicle speed

When the vehicle speed exceeds 8 km/h, all doors can be locked automatically under this function.

Note: *When the vehicle is powered off, the doors will automatically unlock.*

Manual side load door(s)

To open the side load door from the outside, unlock the vehicle, and pull up the door outer handle to slide the side load door rearward. To close the side load door from the outside, pull up the door outer handle to slide the side load door forward till it is closed.

To lock from the inside, close the door and push the button (1) towards the front of the vehicle. To unlock from the inside, push the button (1) towards the rear of the vehicle until the red mark is shown.

To open the side load door from the inside, hold the handle (2) and pull it towards the rear of the vehicle after unlocking. To close the side load door from the inside, hold the handle (2) and pull it towards the front of the vehicle.

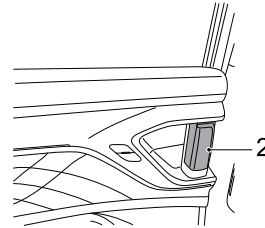
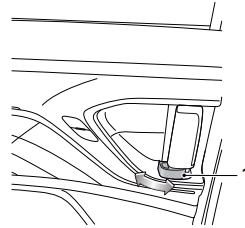

Note: *When the charging port door is open, the left side load door should not be opened.*

Electric side load door(s)

The electric side load door can be opened in multiple ways electrically, and you can open and close the electric side load door according to your vehicle's configuration.

Side load door outer handle

After the vehicle is unlocked, pull up the door outer handle to automatically open the electric side load door. After the electric side load door is fully opened, pull up the door outer handle to automatically close the electric side load door. During automatic opening and closing of the electric side load door, pull up the door outer handle to stop movement of the electric side load door.

After the vehicle is unlocked, long press the micro switch on the door outer handle for 2 seconds to automatically open the electric side load door. After the electric side load door is fully opened, long press the micro switch on the door outer handle for 2 seconds to automatically close the electric side load door. During automatic opening and closing of the electric side load door, short press the micro switch to stop movement of the electric side load door.

Note: When the vehicle is locked, carry a legal key and long press the micro switch on the door outer handle for 2 seconds to automatically unlock and open the electric side load door.

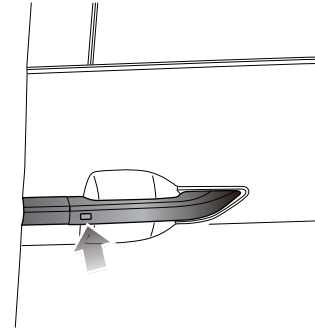

Side load door inner handle

When locking the side load door from the inside, hold the inner handle (2) and pull it towards the front of the vehicle to automatically close the electric side load door. After the electric side load door is closed, push the button (1) towards the front of the vehicle to lock the side load door.





When unlocking the side load door from the inside, push the button (1) towards the rear of the vehicle to show the red mark. After unlocking the electric side load door, hold the inner handle (2) and pull it towards the rear of the vehicle to automatically open the electric side load door.

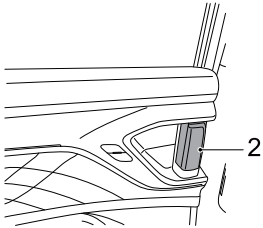
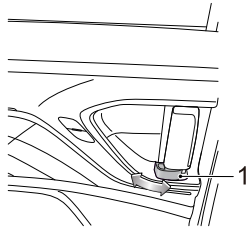



During automatic opening and closing of the electric side load door, pull the door inner handle forward or backward to stop movement of the electric side load door.

Before You Drive



Electric side load door open/close button on the remote key with PEPS

When the right electric side load door is closed, long press the button  to automatically open the right side load door; during opening, short press the button  to stop operation of the right side load door; when the right electric side load door is open, long press the button  to automatically close the right side load door; during closing, short press the button  to stop operation of the side load door.

When the left electric side load door is closed, long press the button  to automatically open the left side load door; during opening, short press the button  to stop operation of the side load door; when the left electric side load door is open, long press the button  to automatically close the left side load door; during closing, short press the button  to stop operation of the side load door.

Note: *This function only can be enabled when the power mode of vehicle is disabled.*

Left/right electric side load door switches on front roof vanity light

After the vehicle is unlocked, long press the electric side load door switch on the front roof vanity light for 2 seconds to automatically open the electric side load door. After the electric side load door is fully opened, long press the electric side

load door switch on the front roof vanity light for 2 seconds to automatically close the electric side load door. During automatic opening and closing of the electric side load door, press this switch to stop movement of the electric side load door.

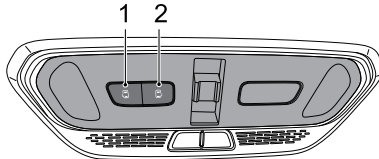

- 1 Left electric side load door switch
- 2 Right electric side load door switch

Electric side load door occupant switches at the B-pillar inner trim panel behind the front seat

After the vehicle is unlocked, long press the electric side load door occupant open switch (1) for 2 seconds to automatically open the electric side load door. After the electric side load door is fully opened, long press the electric side load door occupant close switch (2) for 2 seconds to automatically close the electric side load door. During automatic opening and closing of the electric side load door, press any of the occupant switches to stop movement of the electric side load door.

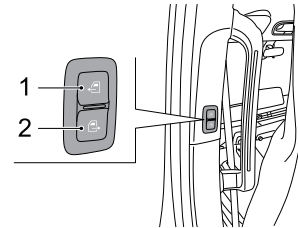

- 1 Electric side load door occupant opening switch
- 2 Electric side load door occupant closing switch

Electric side load door touch buttons on the center console screen

The touch buttons on the center console screen control the opening and closing of the electric side load door.

Note: After the ignition switch is turned on, the electric side load door can be opened and closed only when the shift lever is in P gear, the electronic brake is applied or the brake pedal is depressed.

When the charging port door is open, the left side load door should not be opened.

The electric side load door cannot be opened and closed for 10 cycles consecutively. Otherwise, the thermal protection may be enabled. If the thermal protection function of the electric side load door is enabled, please do not operate the electric side load door any more, and wait for 1 minute

Before You Drive

until the thermal protection function is disabled prior to operation of the electric side load door.

If the side load door encounters any obstacle in the cycle of electric opening or closing, the electric side load door will reverse itself by 10 cm to avoid the obstacle. After the obstacle is removed, the electric side load door can be operated again. If the side load door encounters some obstacles for 3 times consecutively in the process of electric closing or opening, the electric function will be disabled. After removing the obstacles, close the side load door manually, and the normal electric operation function will be recovered. The anti-pinch sensor is located on the side of electric side load door. When the electric side load door is closed, if there is any obstacle between the side load door and the vehicle, and the sensor is extruded, the side load door will reserve itself by 10 cm.

When the electric side load door is operating, make sure that there is no person in the path of opening and closing the side load door, otherwise you or other persons may get injured.

If the vehicle is on a ramp of 12° or above, please close the side load door manually for assistance.

If the battery is disconnected or the voltage is too low, the electric side load door cannot be opened. When the battery is reconnected or charged, the electric side load door will recover normal operation.

Manual tailgate

Unlocking/opening doors from the outside

When using the remote key with PEPS or central lock switch to lock or unlock all doors, the tailgate will also be locked or unlocked.

If the tailgate is unlocked, press the handle switch  and pull it up to open the tailgate.

Note: The tailgate will be opened while swinging up. When opening the tailgate, make sure that there are no objects or people near the rear of vehicle.

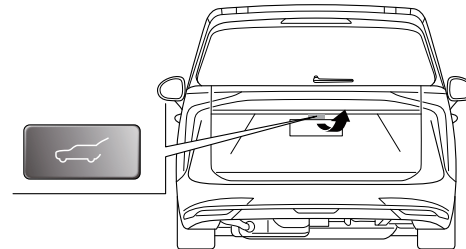

Before You Drive

Closing/locking doors from the outside

To close the tailgate, lower and press it down firmly. Make sure that the tailgate is firmly locked.

Note: Make sure that the tailgate has been closed before driving the vehicle. Driving the vehicle with tailgate not closed may result in the damages of tailgate gas strut and other components.

Emergency lock function

The tailgate has the emergency lock function. When the vehicle is powered off or other conditions cause the tailgate to fail, open the cover at the lower end of the tailgate inner trim panel and press the white lever to open the tailgate.

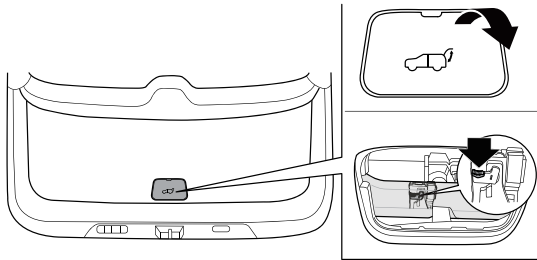



Power tailgate

Note: The tailgate will be opened while swinging up. When opening the tailgate, make sure that there are no objects or people near the rear of vehicle. Make sure that the tailgate has been closed before driving the vehicle. Driving the vehicle with tailgate not closed may result in the damages of tailgate gas strut and other components.

Note: The power tailgate can be opened in multiple ways electrically, and you can open and close the tailgate according to your vehicle's configuration.

Tailgate outer panel switch outside the tailgate

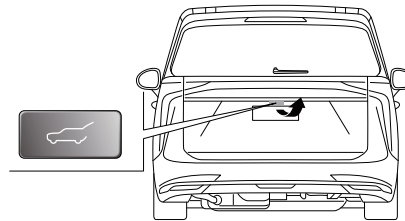

After the vehicle is unlocked, press the tailgate outer panel switch  to open the tailgate.

After the vehicle is locked, carry the remote key with PEPS within 1 m near the tailgate, and press the tailgate outer panel switch  to open the tailgate.



Before You Drive

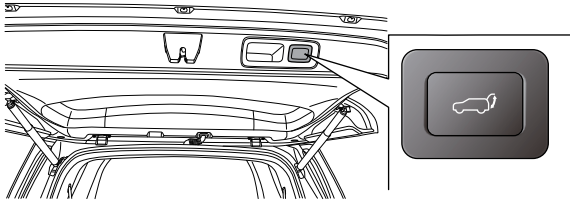

Tailgate inner panel switch inside the tailgate

Press the tailgate inner panel switch  to open and close the tailgate. If the tailgate is open, press the tailgate inner panel switch  to close the power tailgate. Switch  can achieve two-way action, i.e. during the tailgate opening or closing, press the switch to perform reverse action.



For vehicles equipped with manual and electric switching function of power tailgate, long press the tailgate inner panel switch for 3 seconds to switch between the manual and electric modes of the power tailgate. After successful switching, the buzzer will sound twice.

Tailgate switch at the driver door

When the power tailgate is closed, press the tailgate switch  at the driver door to open the tailgate; during opening, press the switch  to stop the tailgate movement, and press the switch  again to reverse the tailgate movement.

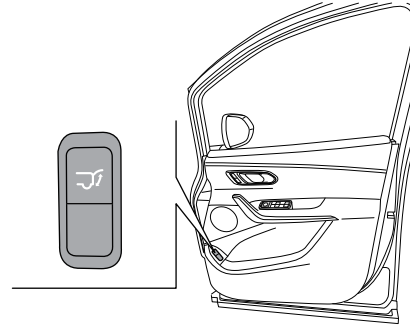

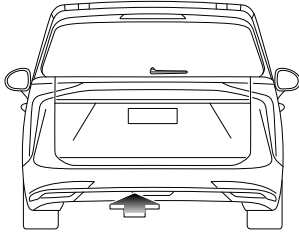

Kick sensing switch at the tailgate

In the power tailgate mode, carry the remote key with PEPS, and do the kick action on the left from the middle of the rear bumper to open the tailgate. To do so, kick slightly forward towards the underside of the rear bumper (as shown), and then retract without touching the bumper.



Note: The kick sensing switch at the tailgate can only open the tailgate, but cannot control the closing of the tailgate. When cleaning the vehicle, do not carry the key near the rear bumper to avoid accidental opening of the tailgate.

Tailgate unlocking button on the remote key with PEPS

Long press the power tailgate unlocking button  on the remote key with PEPS to open and close the power tailgate. During opening and closing, short press the button  to stop the tailgate movement, and long press the button  again to reverse the tailgate movement.

Note: This function only can be enabled when the power mode of vehicle is disabled.

Power tailgate touch buttons on the center console screen

The touch buttons on the center console screen control the opening and closing of the power tailgate and adjust the tailgate opening.

Note: Make sure that the tailgate has been closed before driving the vehicle. Driving the vehicle with tailgate not closed may result in the damages of tailgate gas strut and other components.

Caution

When the power tailgate is operating, make sure that there is no person in the path of opening and closing the tailgate, otherwise you or other person may get injured.

Note: When the tailgate is opened after the vehicle is locked, if you leave the remote key with PEPS in the vehicle and then close the tailgate, the hazard warning light in the vehicle will flash and the tailgate will automatically open. At this time, you should take out the remote key with PEPS and close the tailgate again.

Before You Drive

Setting of tailgate opening modes

The power tailgate has three opening modes.

Manual mode

Unlocking is supported, and the tailgate does not automatically open.

Garage mode

When the tailgate garage mode switch button is pressed in the garage mode, the tailgate will be opened to the set garage height. The default opening of the tailgate in garage mode is 75%.

Garage mode setting: Manually open the tailgate to the desired height, and long press the tailgate inner panel switch  for 2 seconds until a "beep" sound is heard, indicating that the setting is successful. Press the garage mode switch to open the tailgate to the garage height.

Fully open mode

The fully open mode is the default mode of the vehicle.

Emergency lock function

The tailgate has the emergency lock function. When the vehicle is powered off or other conditions cause the power tailgate to fail, open the cover at the lower end of the tailgate inner trim panel and press the white lever to open the tailgate.

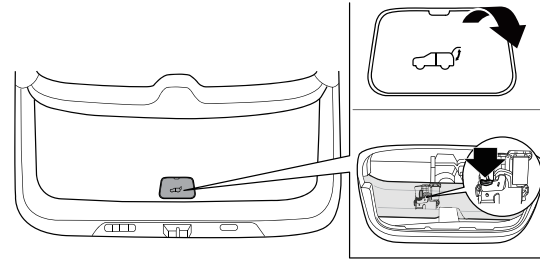

Note: For the vehicles with automatic transmissions, the power tailgate can only be opened and closed at parking gear, which is unavailable at other gears; for the vehicles with manual transmissions, the power tailgate can be opened and closed at all gears.

If no work instruction is received 15 minutes after the power tailgate is opened, the tailgate enters the sleep mode. If you trigger the switch again, the tailgate will close at a constant speed, and then the normal electric function can be restored.

Before You Drive

The power tailgate can not be opened and closed for 10 cycles consecutively. Otherwise, the thermal protection may be enabled. If the thermal protection for the tailgate of your vehicle is enabled, please do not operate the tailgate any more, and wait for 1 minute until the thermal protection is disabled prior to re-operating the tailgate.

If the tailgate encounters any obstacle in the cycle of electric opening or closing, the tailgate will reverse itself to avoid the obstacle. After the obstacle is removed, the power tailgate can be operated again. If the tailgate encounters some obstacles for 3 times consecutively in the process of electric closing or opening, the electric function will be disabled. After removing the obstacles, close the tailgate manually, and the normal electric operation function will be recovered. The anti-pinch sensor is located on the side of tailgate. When the tailgate is closed, if there is any obstacle between the tailgate and vehicle, and the sensor is extruded, the tailgate will reserve itself by 5°.

When the power tailgate is operating, make sure that there is no person in the path of opening and closing the tailgate, otherwise you or other person may get injured.

Tailgate servo strategy: when the power tailgate is half-open, it will be closed automatically under any force.

Do not force to open or close the tailgate in the cycle of electric operation.

If the vehicle is on the ramp of greater than 12°, please close the tailgate manually for assistance, and note that the action must be slowly rather than quickly and forcefully.

If the battery is disconnected or the voltage is too low, the tailgate will not be opened. When the battery is re-connected or charged, the tailgate will recover to normal operation.

Caution

When the power tailgate is operating, make sure that there is no person in the path of opening and closing the tailgate, otherwise you or other person may get injured. When you wash your vehicle, ensure the remote key with PEPS is kept away from the rear bumper detection area, as flushing may cause the tailgate to open. If the rear bumper is covered with a lot of ice, snow, dirt or similar objects, the tailgate sensitive opening function will weaken or not work, so please keep it clean.

Before You Drive

Child safety lock

! If any child sits in the rear seat, please use the child safety lock.

Your vehicle is configured with a child safety lock on each side load door. These locks are used to prevent the occupants (especially children) from pulling the inner door handle from the inside to open the side load door.

Caution

When the child safety lock is in the locking position, do not pull the inner door handle forcefully. Doing so may damage the inner door handle.

To enable the child safety lock:

- 1 Open the side load door to be locked.
- 2 Find the child safety lock nearly in the central position of the side load door on one side, and open the panel of the child safety lock.
- 3 Move the control lever down to the locking position.

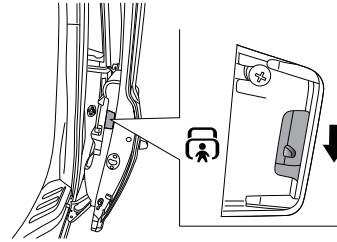

Caution

Each side load door has its own lock. The child safety lock of each side load door (either on the left or right) shall be respectively enabled and disabled manually.

After the child safety lock is enabled, the side load door can only be opened by operating the outer door handle from outside.

To cancel the child safety lock, push the control lever up to the unlocking position.

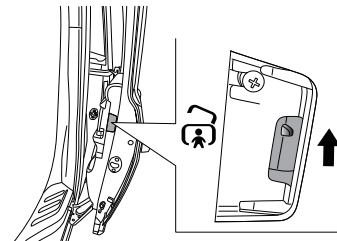

Windows



It is dangerous to leave children, incapacitated adults or pets on the vehicle with windows closed. They may faint out due to high temperature, or suffer permanent injury or even death due to heat stroke. Do not leave children, incapacitated adults or pets on the vehicle with the windows closed, especially in the warm or hot weather.

Power windows



Always take care when operating the power window. There is a risk of injury, especially for children. Please pay close attention when closing the window. Ensure that no objects are stuck in it while the window is moving.

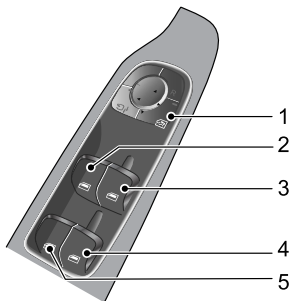

- 1 Rear window disable switch
- 2 Left front door window control switch
- 3 Right front door window control switch
- 4 Right side load door window control switch
- 5 Left side load door window control switch

Press the switches (2) to (5) , to lower the window glass; lift the switch, to move the window glass up. Release the switch, and the window stops working (except for "One-button" mode)

Note: The front door and side load door windows can also be controlled by using the window switch on each door. If the rear window disable switch on driver door is activated, the window control switch on the side load door does not work.

Rear window disable switch

Press the switch (1)  to disable the window control (the indicator on the switch illuminates at this time), and press the switch again to resume the control.



Note: When a child sits on the rear seat, the disable function shall be enabled.

Before You Drive

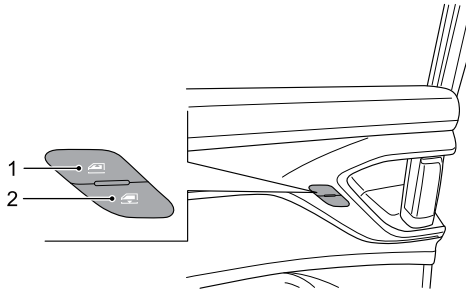
Window control switch on side load door



- 1 Window opening switch on side load door
- 2 Window closing switch on side load door

Press the switch (1)  to close the side load door window at the corresponding side, and press the switch (2)  to open the side load door window at the corresponding side.

Note: The power window can operate only when the vehicle is powered on.

Note: Please operate the windows correctly to avoid danger, and the driver should provide guidance on usage of windows and safety precautions.

Automatic up/down function of window

"One-button" down

Window control switches (2) to (5)  have two positions, short press to the second position, and the window automatically opens. During the window glass down process, operate the switch again to stop the window glass moving down.

"One-button" up and "Anti-pinch"

The right front door window has "One-button" up function; briefly lift the window control switch (2)  to the second position, and the window glass automatically moves up to close; operate the switch again to stop the movement of window glass at any time.

"Anti-pinch" function is a kind of safety function, which can allow the window glass to stop moving up when obstacles are sensed. If this situation occurs, the window glass will automatically moves down to take out obstacles.

The left front door window and side load door window of some models also have "One-button" up and "Anti-pinch" functions, whose operation methods are the same as those of right front window.

Micro switch on door handle

Long press the micro switch on door handle to automatically close the windows of front rows.

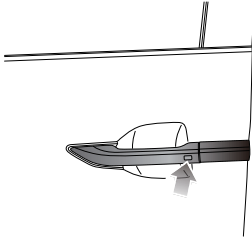

Note: For the function of "long press the micro switch on door handle to automatically close the windows of front rows", please refer to the actual configuration of your vehicle.

Resume the automatic up/down function

If the vehicle battery cable is re-connected after the disconnection, or the battery was drained once, or the anti-pinch function has been enabled for 3 consecutive times at the same position when the window glass moves up, the automatic up/down function may not work, it must be re-learned to restore the function. Close all doors, pull up the window up/down switch, until the window is fully closed, hold the switch for about several seconds after the window is fully closed; then press the window up/down switch until the window is fully open, hold the switch for about several seconds after the window is fully open, the automatic up/down function will be recovered.

Power sunroof

Note: It applies to vehicles configured with power sunroof.

Instructions

! Do not allow occupants to extend any part of their bodies out of the sunroof while driving - to avoid injuries caused by flying objects or tree branches.

- Do not open the sunroof in rainy day. When the vehicle speed is more than 120km/h, it's better not to open the sunroof.
- Remove the accumulated water from the sunroof glass before opening the sunroof, otherwise water drop may slide off when the sunroof is opened. Use cleaner like alcohol to clean the glass.
- After operation on the sunroof is completed, please release the sunroof operation switch in time, otherwise it may cause failure.
- To ensure normal operation of sunroof, please clean the sunroof frequently and go to Our Service Dealer for sunroof maintenance according to the maintenance requirements.

! When operating the sunroof, be sure to keep persons in the vehicle safe, especially children; do not put any part of body or objects into the sunroof, to prevent being pinched by the sunroof.

Note: The power window can operate only when the vehicle is powered on.

Before You Drive

Operation method of front sunroof

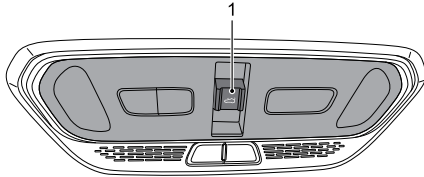

Press the front sunroof opening button (1) once, and the front sunroof will be lifted to the position for ventilation.

The front sunroof will be opened manually when the button (1) is pushed toward the rear of the vehicle by one gear; the front sunroof will slide to the fully open position when the button (1) is pushed toward the rear of the vehicle by two gears.

The front sunroof will be closed manually when the button (1) is pushed toward the front of the vehicle by one gear; the front sunroof will slide to the fully closed position when the button (1) is pushed toward the front of the vehicle by two gears.

During the automatic operation, the button (1) can be pressed once, to make the sunroof stop at the required position.

Front sunroof initialization

With the front sunroof in the fully closed position, press and hold the button (1) for more than 10 seconds toward the front of the

vehicle, at this time, the sunroof will move toward the opening direction, then move toward the closing direction after reaching a certain position. Continue to press and hold the button (1) until the front sunroof glass is fully closed, then release the switch again, thus the initialization operation of the front sunroof has been completed.

Note: During the initialization process, if you inadvertently release the button (1), resulting in the loss of automatic opening and closing function of the front sunroof, just repeat the initialization operation and it will return to normal after completion. If repeated operations still fail to restore the front sunroof, please contact Our Service Dealer for service.

Operation method of panoramic sunroof

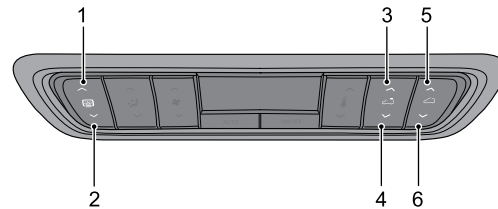



1 Sunshade opening switch

Note: The sunshade opening/closing switch has auto and jog functions, which can conveniently control the opening and closing process of sunshade. Short press the switch, to open or close the sunshade in jog mode; long press the switch to automatically open or close the sunshade.

- 2 Sunshade closing switch
- 3 Panoramic sunroof opening switch
- 4 Panoramic sunroof closing switch
- 5 Panoramic sunroof lifting-open switch
- 6 Panoramic sunroof lifting-close switch



Panoramic sunroof initialization

When the panoramic sunroof movement logic disorder occurs, manual initialization operation can be performed to restore the panoramic sunroof movement to normal.

With the panoramic sunroof glass fully open and the sunshade fully open, long press  panoramic sunroof opening switch (3) for about 10 seconds, then the sunroof glass will begin to close; after the glass are fully closed, the sunshade will begin to close. While the sunroof glass and sunshade are running, press and hold  the panoramic sunroof opening switch (3) until the sunroof glass and sunshade are fully closed, then release the switch again, thus the initialization operation of the panoramic sunroof has been completed.

Note: During the initialization process, if accidentally release the panoramic sunroof opening switch (3) , causing the loss of automatic opening and closing function of the panoramic sunroof, at this time, it is only required to repeat the initialization operation, and the function will return to normal after the completion. If repeated operations still fail to restore the panoramic sunroof, please contact Our Service Dealer for service.

Caution

If it is found that the sunroof glass cannot be opened when it is not fully open, try to long press  button, at this time, the sunroof will open in jog mode to full open, and then you can perform the initialization operation. If you long press  button and the sunroof still does not work, in this state, please long press  for 10 seconds, to perform the initialization operation directly. If repeated operations still fail to restore the panoramic sunroof, please contact Our Service Dealer for service.

Before You Drive

Seats

Driver seat adjustment

! Do not adjust the driver seat while the vehicle is moving. Otherwise, the vehicle may lose control and cause an accident.

Manually adjusted driver seat

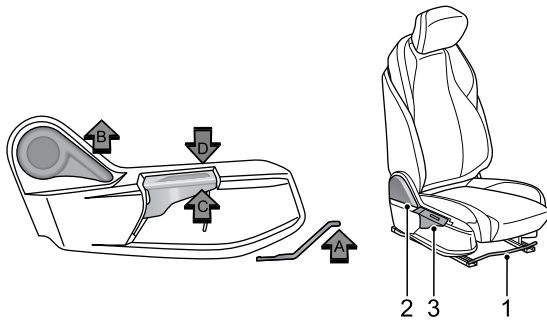

Forward/backward sliding

When the adjuster (1) is pushed up (arrow A), the track will be unlocked, and the seat can be moved forward and backward. When the seat slides to the desired position, release the adjuster (1) to stop the seat sliding.

Rake adjustment of backrest

! Do not recline the seat excessively as the seat belt provides maximum protection only when the angle between the backrest and the upright position is near 25°.

When the angle adjustment armrest (2) is pushed up (arrow B), the backrest is unlocked and can tilt forward and backward. When the seat backrest tilts to the desired position, release the angle adjustment armrest (2) to stop the backrest tilting.

Cushion height adjustment

When the front end of the height adjustment armrest (3) is pushed up (arrow C), the cushion will move upward. When the cushion rises to the desired position, release the height adjustment armrest (3) to stop the cushion movement.

When the front end of the height adjustment armrest (3) is pushed down (arrow D), the cushion will move downward. When the cushion falls to the desired position, release the height adjustment armrest (3) to stop the cushion movement.

Before You Drive

Electrically adjusted driver seat (Type 1)

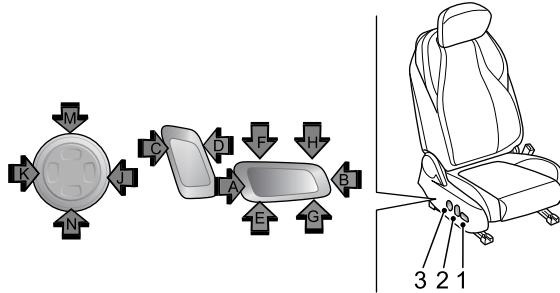

Caution

The seat can be freely adjusted regardless of whether the vehicle is powered on or not. But the electrical adjustment consumes the power of the vehicle battery, which may drain the battery.

Forward/backward sliding

When the button (1) is pushed forward (arrow A), the seat will move forward, and when the seat slides to the desired position, release the button (1) to stop the seat sliding.

When the button (1) is pushed backward (arrow B), the seat will move backward, and when the seat slides to the desired position, release the button (1) to stop the seat sliding.

Rake adjustment of backrest

! Do not recline the seat excessively as the seat belt provides maximum protection only when the angle between the backrest and the upright position is near 25°.

When the button (2) is rotated forward (arrow C), the seat backrest will tilt forward, and when the seat backrest tilts to the desired position, release the button (2) to stop the backrest tilting.

When the button (2) is rotated backward (arrow D), the seat backrest will tilt backward, and when the seat backrest tilts to the desired position, release the button (2) to stop the backrest tilting.

Cushion height adjustment

When the rear end of the button (1) is pushed up (arrow E), the cushion will move upward, and when the cushion rises to the desired position, release the button (1) to stop the cushion movement.

When the rear end of the button (1) is pushed down (arrow F), the cushion will move downward, and when the cushion falls to the desired position, release the button (1) to stop the cushion movement.

Before You Drive

Rake adjustment of cushion

When the front end of the button (1) is pushed up (arrow G), the front end of the cushion will move upward while the upper end of the backrest tilts backward, and when the cushion tilts to the desired position, release the button (1) to stop the cushion movement.

When the front end of the button (1) is pushed down (arrow H), the front end of the cushion will move downward while the upper end of the backrest tilts forward, and when the cushion tilts to the desired position, release the button (1) to stop the cushion movement.

Lumbar support adjustment

When the front end of the button (3) is pressed and held (arrow J), the lumbar support moves forward, and when the lumbar support moves to the desired position, release the button to stop the lumbar support movement.

When the rear end of the button (3) is pressed and held (arrow K), the lumbar support moves backward, and when the lumbar support moves to the desired position, release the button to stop the lumbar support movement.

When the upper end of the button (3) is pressed and held (arrow M), the lumbar support moves upward, and when the lumbar support moves to the desired position, release the button to stop the lumbar support movement.

When the lower end of the button (3) is pressed and held (arrow N), the lumbar support moves downward, and when the lumbar

support moves to the desired position, release the button to stop the lumbar support movement.

Armrest adjustment

Note: It applies to vehicles configured with armrest adjustment function.

The armrest can be adjusted upwards from the lowest position as needed. There are 3 positions in total.

When it is required to lower the armrest from a higher position, it is necessary to raise the armrest to the highest position first, then lower the armrest to the lowest position, and then adjust the armrest upwards to the desired position.

Electrically adjusted driver seat (Type 2)

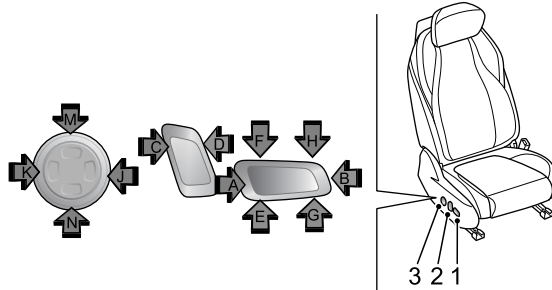

Caution

Regardless of whether the vehicle is powered on or not, the forward/backward sliding, rake adjustment of backrest, rake adjustment of cushion, cushion height adjustment, seat lumbar support adjustment and memory position function can be realized for the seat, but the electrical adjustment consumes the power of the vehicle battery, which may drain the battery. The massage function can be used only after the vehicle is powered on.

Note: You can enter the seat interface on the center console screen to perform function adjustment for the corresponding seat.

Forward/backward sliding

When the button (1) is pushed forward (arrow A), the seat will move forward, and when the seat slides to the desired position, release the button (1) to stop the seat sliding.

When the button (1) is pushed backward (arrow B), the seat will move backward, and when the seat slides to the desired position, release the button (1) to stop the seat sliding.

Rake adjustment of backrest

! Do not recline the driver seat excessively, as the seat belt provides maximum protection only when the angle between the backrest and the upright position is near 25°.

When the button (2) is rotated forward (arrow C), the seat backrest will tilt forward, when the seat backrest tilts to the desired position, release the button (2) to stop the backrest tilting.

When the button (2) is rotated backward (arrow D), the seat backrest will tilt backward, and when the seat backrest tilts to the desired position, release the button (2) to stop the backrest tilting.

Cushion height adjustment

When the rear end of the button (1) is pushed up (arrow E), the cushion will move upward, and when the cushion rises to

Before You Drive

the desired position, release the button (1) to stop the cushion movement.

When the rear end of the button (1) is pushed down (arrow F), the cushion will move downward, and when the cushion falls to the desired position, release the button (1) to stop the cushion movement.

Rake adjustment of cushion

When the front end of the button (1) is pushed up (arrow G), the front end of the cushion will move upward while the upper end of the backrest tilts backward, and when the cushion tilts to the desired position, release the button (1) to stop the cushion movement.

When the front end of the button (1) is pushed down (arrow H), the front end of the cushion will move downward while the upper end of the backrest tilts forward, and when the cushion tilts to the desired position, release the button (1) to stop the cushion movement.

Lumbar support adjustment

When the front end of the button (3) is pressed and held (arrow J), the lumbar support moves forward, and when the lumbar support moves to the desired position, release the button to stop the lumbar support movement.

When the rear end of the button (3) is pressed and held (arrow K), the lumbar support moves backward, and when the lumbar

support moves to the desired position, release the button to stop the lumbar support movement.

When the upper end of the button (3) is pressed and held (arrow M), the lumbar support moves upward, and when the lumbar support moves to the desired position, release the button to stop the lumbar support movement.

When the lower end of the button (3) is pressed and held (arrow N), the lumbar support moves downward, and when the lumbar support moves to the desired position, release the button to stop the lumbar support movement.

Memory position function

The seat memory position function has 3 positions. After entering the seat interface on the center console screen, adjust the seat (backrest/forward/backward sliding/front height adjustment/rear lifting and other functions) to the desired position first, select the driver memory touch button 1/2/3, and press and hold it for about 2 seconds, until the center console screen prompts successful saving (If we adjust the seat to a position other than memory 1, and want to restore to the position of memory 1, short press the memory button 1, the seat will move to the stored position of memory 1).

To adjust the electrically adjusted front occupant seat (type 2), select the front occupant memory touch button, with the same operation method as the driver memory.

Before You Drive

Massage function

The seat massage function has 8 modes, and each mode has three positions: high, medium and low. Enter the seat interface on the center console screen, select the driver massage touch button, and adjust according to the prompts.

To adjust the electrically adjusted front occupant seat (type 2), select the front occupant massage touch button and adjust according to the prompts.

Heating function

The seat heating function has 3 positions. Enter the A/C interface on the center console screen, select the driver seat heating touch button, and adjust according to the prompts.

To adjust the electrically adjusted front occupant seat (type 2), select the front occupant seat heating touch button and adjust according to the prompts.

Ventilation function

The seat ventilation (blowing) function has 3 positions. Enter the A/C interface on the center console screen, select the driver seat ventilation touch button, and adjust according to the prompts.

To adjust the electrically adjusted front occupant seat (type 2), select the front occupant seat ventilation touch button and adjust according to the prompts.

Note: The cushion heating function and ventilation function cannot be used at the same time.

Front occupant seat adjustment

Manually adjusted front occupant seat

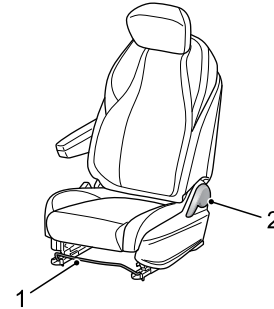

Forward/backward sliding

Pull up the adjuster (1), and slide the seat to the desired position. Release the adjuster (1) and check that the seat is locked in position.

Rake adjustment of backrest

! Do not recline the front occupant seat excessively, as the seat belt provides maximum protection only when the angle between the backrest and the upright position is near 25°.

Before You Drive

Slightly recline forward and pull up the adjuster (2); the seat backrest rebounds automatically. Then lean against the backrest to adjust it to the desired angle. Release the adjuster (2) and check that the seat backrest is locked in position.

Armrest adjustment

The armrest can be adjusted upwards from the lowest position as needed. There are 3 positions in total.

When it is required to lower the armrest from a higher position, it is necessary to raise the armrest to the highest position first, then lower the armrest to the lowest position, and then adjust the armrest upwards to the desired position.

Electrically adjusted front occupant seat (Type 1)

Only forward/backward sliding, rake adjustment of backrest and lumbar support adjustment can be made, and its adjustment method is the same as that of electrically adjusted driver seat (type 1).

Electrically adjusted front occupant seat (Type 2)

Only forward/backward sliding, rake adjustment of backrest, memory position function, lumbar support adjustment, massage function, heating function and ventilation function can be realized, and its adjustment method is the same as that of the electrically adjusted driver seat (type 2).

2nd row seat adjustment

Manually adjusted single seat

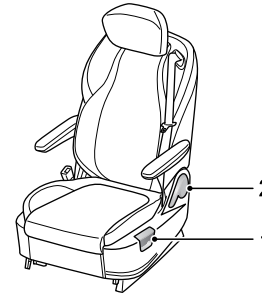

Note: *The adjuster of the right seat is on the right of the seat, while the adjuster of the left seat is on the left of the seat.*

Forward/backward sliding

Lift the adjuster (1) upward, and adjust the seat position forward and backward by pulling/pushing it forward/backward with both feet. Release the adjuster (1), and check that the seat is locked in position.

Before You Drive

Rake adjustment of backrest

Pull up the adjuster (2), and then lean against the backrest to adjust it to the desired angle. Release the adjuster (2) and check that the seat backrest is locked in position.

Seat cup holder

The retractable cup holder automatically pops out by tapping slightly; to retract the cup holder, push it in until it locks.

The retractable cup holder of the left single seat is on the right of the seat.

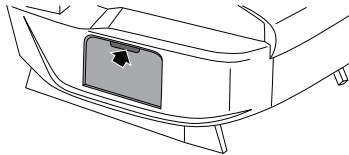

The right single seat has no cup holder, but has two USB charging ports.

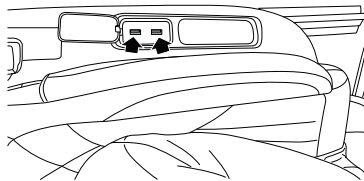

Armrest adjustment

The armrest can be adjusted upwards from the lowest position as needed. There are 8 positions in total.

When it is required to lower the armrest from a higher position, it is necessary to raise the armrest to the highest position first, then lower the armrest to the lowest position, and then adjust the armrest upwards to the desired position.

1

Before You Drive

Electrically adjusted single seat (Type 1)

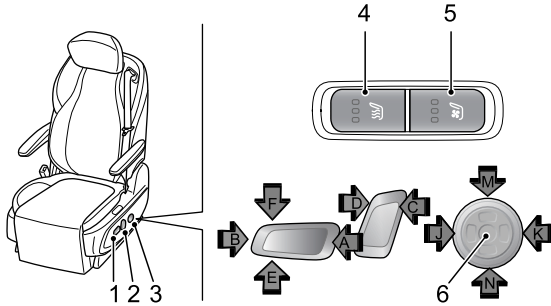

Caution

The seat can be freely adjusted regardless of whether the vehicle is powered on or not. But the electrical adjustment consumes the power of the vehicle battery, which may drain the battery.

Note: *The adjustment button of the right seat is on the right of the seat, while the adjustment button of the left seat is on the left of the seat.*

Forward/backward sliding

When the button (1) is pushed forward (arrow A), the seat will move forward, and when the seat slides to the desired position, release the button (1) to stop the seat sliding.

When the button (1) is pushed backward (arrow B), the seat will move backward, and when the seat slides to the desired position, release the button (1) to stop the seat sliding.

Rake adjustment of backrest

! Do not recline the seat excessively as the seat belt provides maximum protection only when the angle between the backrest and the upright position is near 25°.

When the button (2) is rotated forward (arrow C), the seat backrest will tilt forward, and when the seat backrest tilts to the desired position, release the button (2) to stop the backrest tilting.

When the button (2) is rotated backward (arrow D), the seat backrest will tilt backward, and when the seat backrest tilts to the desired position, release the button (2) to stop the backrest tilting.

Seat leg support adjustment

When the button (1) is pushed forward (arrow E), the leg support will tilt upward, and when the leg support tilts to the desired position, release the button (1) to stop the leg support tilting.

When the rear end of the button (1) is pushed down (arrow F), the cushion will move downward, and when the cushion falls to the desired position, release the button (1) to stop the cushion movement.

Lumbar support adjustment

When the front end of the button (3) is pressed and held (arrow J), the lumbar support moves forward, and when the lumbar support moves to the desired position, release the button to stop the lumbar support movement.

When the rear end of the button (3) is pressed and held (arrow K), the lumbar support moves backward, and when the lumbar support moves to the desired position, release the button to stop the lumbar support movement.

When the upper end of the button (3) is pressed and held (arrow M), the lumbar support moves upward, and when the lumbar support moves to the desired position, release the button to stop the lumbar support movement.

When the lower end of the button (3) is pressed and held (arrow N), the lumbar support moves downward, and when the lumbar support moves to the desired position, release the button to stop the lumbar support movement.

Massage function

When (6) in the middle of the button (3) is pressed and held, the massage starts, first up and then down, and then massage at the same time, in cycle and without time limit.

Press (6) in the middle of the button (3) again or activate the lumbar support in the midway to stop massage.

Ventilation function

When pressing the ventilation button (5) once, the fan starts in the 3rd position, and LED1, LED2, and LED3 are on; when pressing the ventilation button (5) twice, the fan starts in the 2nd position, LED1 is off, while LED2 and LED3 are on; when pressing the ventilation button (5) three times, the fan starts in the 1st position, LED1 and LED2 are off, while LED3 is on. When pressing the ventilation button again, the ventilation function is deactivated, and LED1, LED2, and LED3 are off.

Heating function

When pressing the heating button (4) once, the heater starts in the 3rd position, and LED4, LED5, and LED6 are on; when pressing the heating button (4) twice, the heater starts in the 2nd position, LED4 is off, while LED5 and LED6 are on; when pressing the heating button (4) three times, the heater starts in the 1st position, LED4 and LED5 are off, while LED6 is on. When pressing the heating button again, the heating function is deactivated, and LED4, LED5, and LED6 are off.

Note: The cushion heating function and ventilation function cannot be used at the same time.

Seat cup holder

The retractable cup holder automatically pops out by tapping slightly; to retract the cup holder, push it in until it locks.

The retractable cup holder of the left single seat is on the right of the seat.

Before You Drive

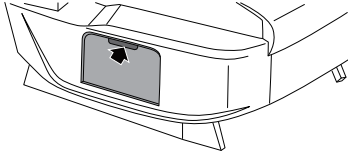

The right single seat has no cup holder, but has USB and Type-C charging ports.

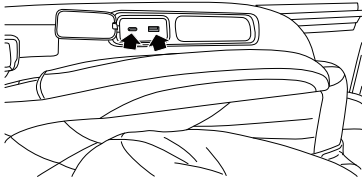

Armrest adjustment

The armrest can be adjusted upwards from the lowest position as needed. There are 8 positions in total.

When it is required to lower the armrest from a higher position, it is necessary to raise the armrest to the highest position first, then lower the armrest to the lowest position, and then adjust the armrest upwards to the desired position.

Electrically adjusted single seat (Type 2)

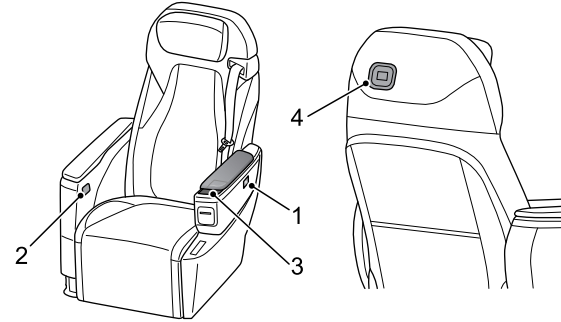

Caution

The seat can be freely adjusted regardless of whether the vehicle is powered on or not. But the electrical adjustment consumes the power of the vehicle battery, which may drain the battery.

Note: *You can enter the seat interface on the center console screen to perform function adjustment for the corresponding seat.*

Before You Drive

Forward/backward sliding

It is controlled via the armrest screen (3). Select the Basic Function button in the seat homepage interface, long press the F symbol to slide the seat forward, and long press the B symbol to slide the seat backward.

Rake adjustment of backrest

It is controlled via the armrest screen (3). Select the Basic Function button in the seat homepage interface, long press the Tilt Forward symbol to tilt the seat forward, and long press the Tilt Backward symbol to tilt the seat back.

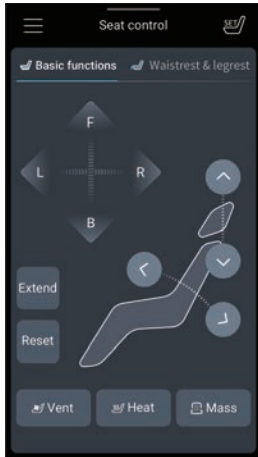

Seat leg support and lumbar support adjustment

It is controlled via the armrest screen (3). Select the Leg and Lumbar Support button in the seat homepage interface, long press the Raise symbol at the leg support to raise the seat leg support, and long press the Lower symbol at the leg support to lower the seat leg support. Long press the Extend symbol at the leg support to extend the seat leg support, and long press the Retract symbol at the leg support to retract the seat leg support. Select the Leg and Lumbar Support button in the seat homepage interface, and long press the symbols at the lumbar support to adjust the seat lumbar support forward/backward/upward/downward.



1

Before You Drive

Headrest adjustment

It is controlled via the armrest screen (3). Select the Basic Function button in the seat homepage interface, long press the Raise symbol to raise the seat headrest continuously, and long press the Lower symbol to lower the seat headrest continuously. Short press the Raise symbol to raise it for a short distance, and short press the Lower symbol to lower it for a short distance.

Lateral sliding

It is controlled via the armrest screen (3). Select the Basic Function button from the seat homepage options, and long press the L/R symbol to slide the seat to left/right.

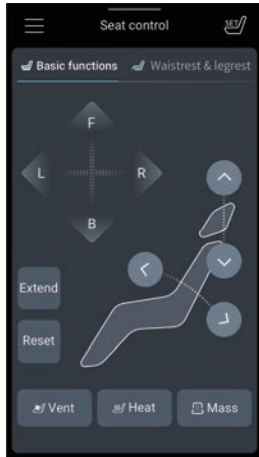

Ventilation

It is controlled via the armrest screen (3). Select the Basic Function button in the seat homepage interface, and then select the Ventilation button to enter the ventilation interface. Ventilation has 3 positions, which is OFF by default. Select the desired position to recall it.

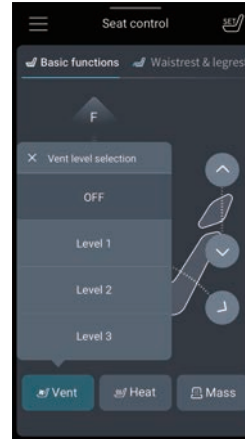

You can also adjust it by entering the A/C interface on the center console screen. The seat ventilation (blowing) function has 3 positions. Enter the A/C interface, select the left/right ventilation touch button, and adjust the ventilation function of the 2nd row left/right seat according to the prompts.

Note: The cushion heating function and ventilation function cannot be used at the same time.

Before You Drive

Heating

It is controlled via the armrest screen (3). Select the Basic Function button in the seat homepage interface, and then select the Heating button to enter the heating interface. Heating has 3 positions, which is OFF by default. Select the desired position to recall it.

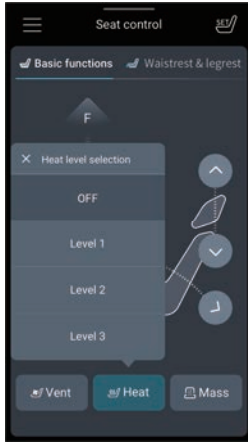

You can also adjust it by entering the A/C interface on the center console screen. The seat heating function has 3 positions. Enter the A/C interface, select the left/right heating touch button, and adjust the heating function of the 2nd row left/right seat according to the prompts.

Note: The cushion heating function and ventilation function cannot be used at the same time.

Massage

It is controlled via the armrest screen (3). Select the Basic Function button in the seat homepage interface, and then select the Massage button to enter the massage interface. Massage has 8 modes, each with 3 positions. Select "OFF" to deactivate the massage function.

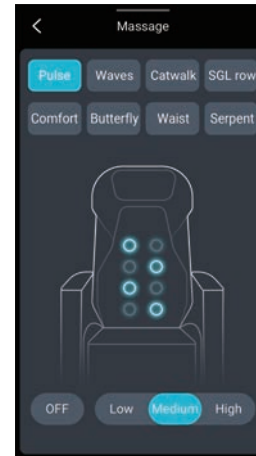

1

Before You Drive

Position memory

It is controlled via the armrest screen (3). Select the  button from the seat homepage options. After opening, three positions can be selected. Select a position, long press it to save this position, and short press it to adjust the seat from other positions to this memory position.

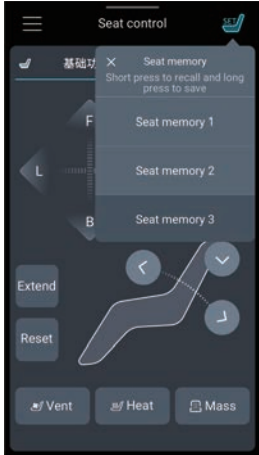

One-touch reclining/retracting

It is controlled via the armrest screen (3). Select the Basic Function button in the seat homepage interface, and then select the Extend button to recline the seat flat. The seat in the armrest screen is reclined to the calibrated position. Select the Reset button to retract the seat to the calibrated position.



One-touch reset function

The button (1) on the side of the seat is for entry. Long press the button (1) to move the front occupant seat, 2nd row seats and 3rd row seats (the 3rd row seats of vehicles with 7 seats do not move) to the calibrated entry position.

Before You Drive

The button (2) on the inner side of the seat is the reset button. Long press the button (2) to return the seat to the calibrated position.

The button (4) at the rear end of the seat backrest is for exit. Long press the button (4) to move the front occupant seat, 2nd row seats and 3rd row seats (the 3rd row seats of vehicles with 7 seats do not move) to the calibrated entry position.

Note: The buttons (1), (2) and (4) have the function to pause seat movement, i.e. during the seat movement or when the seat moves and the armrest screen control fails, short press any of the buttons (1), (2) and (4) to pause the seat movement.

Cover above armrest screen

The cover above the armrest screen can be slid forward or backward by pressing the following buttons.

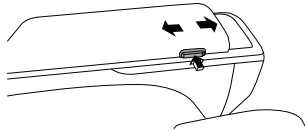
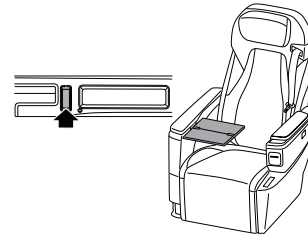

Table function

Open the cover on the inner large armrest and press the following button. After pressing the button, the table will pop out of the armrest, and then it can be laid flat or rolled out. The table can be unfolded and slid forward.



To put back the table, fold it first, move it to the last position to make it upright, push it down into the large armrest until a "click" sound is heard, indicating that it has been completely put back, and then close the cover on the inner large armrest.

Seat cup holder

The pop-up cup holder automatically pops out by pressing inward; to retract the cup holder, push it in until it locks. The pop-up cup holder of the left single seat is on the left of the seat. The pop-up cup holder of the right single seat is on the right of the seat.

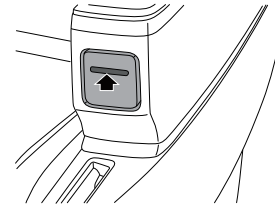

Before You Drive

Single fixed seat in manually adjusted triple seat

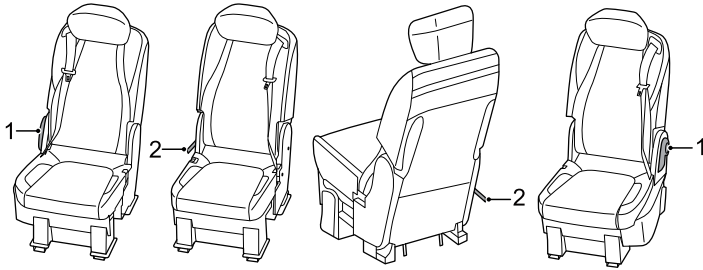

Note: *The adjuster of right single seat is on the right of the seat, the adjuster of left single seat is on the left of the seat, and the adjuster of middle single seat is on the right of the seat.*

Rake adjustment of backrest

Pull up the adjuster (1) or pull the adjuster tether (2) to unlock the seat backrest, and after adjusting the seat backrest forward or backward to the desired position, release the adjuster (1) or adjuster tether (2) and confirmed that the seat backrest is locked in position, to complete the seat backrest adjustment. The seat backrest can be tilted forward or laid flat.

Tilting Seat forward or putting down seat

Tilting seat forward: Rotate the parking lock release handle (3) upward or pull the parking lock release tether (middle seat) (4) downward at the same time, to unlock the rear feet of seat; lift

the rear end of seat until a locking sound is heard, to complete tilting seat forward.

Putting down seat: With the seat tilted forward, rotate the parking lock release handle (counterclockwise on the left/clockwise on the right) (3) or pull the parking lock release tether (middle seat) (4) downward at the same time, to unlock the seat; put down the seat backward until the seat is locked and a locking sound is heard, to complete putting down the seat.

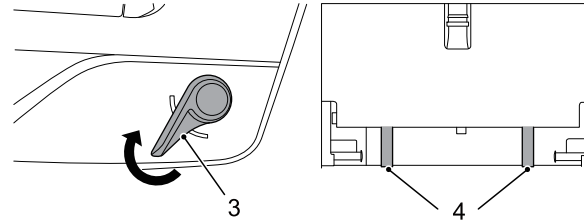

Note: *When forward tilting function is used, the seat backrest shall be tilted forward/laid flat/locked; the parking lock release handle of right single seat is on the right of the seat, the parking lock release handle of the left single seat is on the left of the seat, and the adjuster of middle single seat is on the right of the seat.*

Before You Drive

Removing or installing seat

Removing seat: With the seat tilted forward or locked, pull up the front parking lock release lever (5) until an unlocking sound is heard, then pull up the seat, to remove the seat.

Installing seat: With the front feet of seat unfolded and locked, pull up the front parking lock release lever (5) to unlock the front feet of seat, then put down the seat until a locking sound is heard after body mounting bracket wire is aligned, to complete installation of front feet of seat if the seat does not shake. Perform "Putting down seat" operation again (power seat should be connected to the body harness before "Putting down seat" operation) until rear feet are locked, to complete installation of seat.

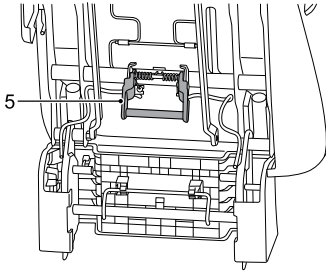

Note: For seat with harness, the connection between the body harness and the seat should be canceled before removing the seat (operate when the seat is tilted forward and locked).

3rd row seat adjustment

Manually adjusted triple seat

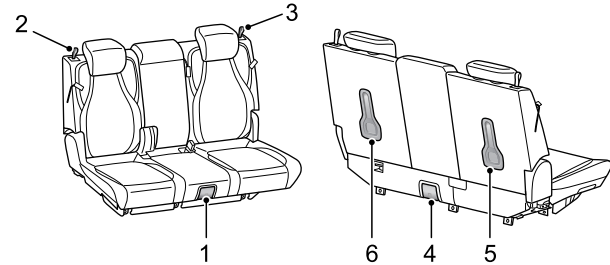

Forward/backward sliding

Lift the adjuster (1)/(4) upward, and adjust the seat position forward and backward by pulling/pushing it forward/backward with both feet. Release the adjuster (1) or adjuster (4), and check that the seat is locked in position.

The forward and backward adjuster for the triple seat is located under the seat.

Rake adjustment of backrest

Slightly recline forward and pull up the adjuster (2)/(3); the seat backrest rebounds automatically. Then lean against the backrest to adjust it to the desired angle. Release the adjuster (2)/(3) and check that the seat backrest is locked in position.

Before You Drive

When the backrest is laid flat, it can be unlocked by pulling the adjuster (5)/(6) to adjust it to the desired position.

The rake adjusters for the triple seat are located on the left and right of the seat.

Electrically adjusted single seat

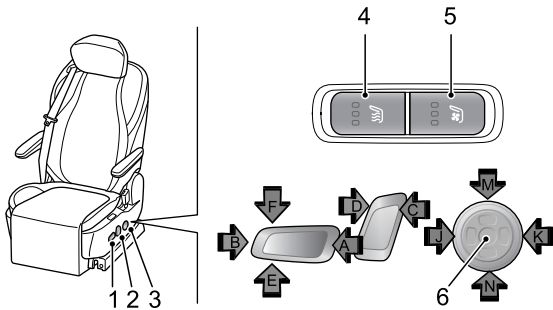

Caution

The seat can be freely adjusted regardless of whether the vehicle is powered on or not. But the electrical adjustment consumes the power of the vehicle battery, which may drain the battery.

Note: *The adjustment button of the right seat is on the left of the seat, while the adjustment button of the left seat is on the right of the seat.*

Note: *You can enter the seat interface on the center console screen to perform function adjustment for the corresponding seat.*

Forward/backward sliding

When the button (1) is pushed forward (arrow A), the seat will move forward, and when the seat slides to the desired position, release the button (1) to stop the seat sliding.

When the button (1) is pushed backward (arrow B), the seat will move backward, and when the seat slides to the desired position, release the button (1) to stop the seat sliding.

Rake adjustment of backrest

! Do not recline the seat excessively as the seat belt provides maximum protection only when the angle between the backrest and the upright position is near 25°.

When the button (2) is rotated forward (arrow C), the seat backrest will tilt forward, and when the seat backrest tilts to the desired position, release the button (2) to stop the backrest tilting.

When the button (2) is rotated backward (arrow D), the seat backrest will tilt backward, and when the seat backrest tilts to the desired position, release the button (2) to stop the backrest tilting.

Seat leg support adjustment

When the button (1) is pushed forward (arrow E), the leg support will tilt upward, and when the leg support tilts to the desired position, release the button (1) to stop the leg support tilting.

When the rear end of the button (1) is pushed down (arrow F), the cushion will move downward, and when the cushion falls to the desired position, release the button (1) to stop the cushion movement.

Lumbar support adjustment

When the front end of the button (3) is pressed and held (arrow J), two air bags of lumbar support deflate and the lumbar support lowers; release the button to stop lowering the lumbar support.

When the rear end of the button (3) is pressed and held (arrow K), two air bags of lumbar support inflate and the lumbar support rises; release the button to stop raising the lumbar support.

When the upper end of the button (3) is pressed and held (arrow M), the upper air bag of lumbar support inflates/the lower air bag deflates, the upper end of lumbar support rises, and the lower end lowers; release the button to stop.

When the lower end of the button (3) is pressed and held (arrow N), the upper air bag of lumbar support deflates/the lower air bag inflates, the upper end of lumbar support lowers, and the lower end rises; release the button to stop.

Massage function

When (6) in the middle of the button (3) is pressed and held, the massage starts, first up and then down, and then massage at the same time, in cycle and without time limit.

Press (6) in the middle of the button (3) again or activate the lumbar support in the midway to stop massage.

Heating function

When pressing the heating button (4) once, the heater starts in the 3rd position, and LED4, LED5, and LED6 are on; when pressing the heating button (4) twice, the heater starts in the 2nd position, LED4 is off, while LED5 and LED6 are on; when pressing the heating button (4) three times, the heater starts in the 1st position, LED4 and LED5 are off, while LED6 is on. When pressing the heating button again, the heating function is deactivated, and LED4, LED5, and LED6 are off.

Note: The cushion heating function and ventilation function cannot be used at the same time.

Ventilation function

When pressing the ventilation button (5) once, the fan starts in the 3rd position, and LED1, LED2, and LED3 are on; when pressing the ventilation button (5) twice, the fan starts in the 2nd position, LED1 is off, while LED2 and LED3 are on; when pressing the ventilation button (5) three times, the fan starts in the 1st position, LED1 and LED2 are off, while LED3 is on. When

Before You Drive

pressing the ventilation button again, the ventilation function is deactivated, and LED1, LED2, and LED3 are off.

Note: The cushion heating function and ventilation function cannot be used at the same time.

The 3rd row electrically adjusted single seats can also be slided forward and backward through the rear body side buttons.

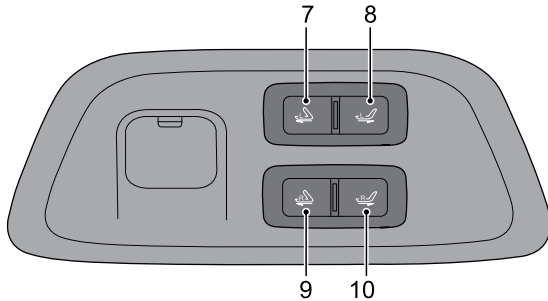

When long pressing the button (7), the left single seat moves forward (retract the leg support first when it is open), and the backrest is retracted to the calibrated angle.

When long pressing the button (8), the left single seat backrest returns to the calibrated angle first, and then the seat moves backward.

When long pressing the button (9), the right single seat moves forward (retract the leg support first when it is open), and the backrest is retracted to the calibrated angle.

When long pressing the button (10), the right single seat backrest returns to the calibrated angle first, and then the seat moves backward.

Note: During the above operations, release the button to stop the seat movement.

Armrest adjustment

The armrest can be adjusted upwards from the lowest position as needed. There are 8 positions in total.

When it is required to lower the armrest from a higher position, it is necessary to raise the armrest to the highest position first, then lower the armrest to the lowest position, and then adjust the armrest upwards to the desired position.

Headrest

 To reduce the risk of neck or head injury, the headrest should be adjusted to support the back of the head but not the neck. Do not adjust the headrest while the vehicle is in motion.

Two-way adjustable headrest

Press the arrowed button to push down or pull up the headrest to adjust the headrest to the desired position. When pulling to a proper position, the headrest can be pulled out.

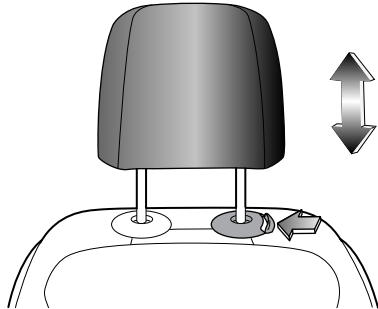

Occupant restraint system

Sitting correctly

The seat and its occupant restraint system have been designed to reduce personal injury to a minimum in the event of an accident. For optimum effectiveness, the following points should be observed.

- Do not position the seat nearer to the steering wheel than it is necessary.
- Do not over-recline the seat. Adjust the seat backrest to no more than 30° so that you can sit in an upright position with your arms slightly bent, and the base of your spine as far back as possible.
- Your headrest should be adjusted so that its center is level with the back of your head, not your neck.
- Diagonal belt should lie across the center of your shoulder (adjust its height if necessary) while lap strap fit tightly across the hips, not the abdomen.

Before You Drive

Seat belts

 Improperly wearing or using seat belts may cause serious personal injury or death. Seat belts are life saving equipment. In a collision, unrestrained occupants may collide anywhere inside the vehicle or be possibly thrown out, resulting in injury to themselves or to other occupants.

When riding in a vehicle, the driver and any adult (or any adult sized child) must always wear the seat belt. Do NOT slacken the webbing by pulling the belt away from your body. To be fully effective, the webbing must remain tightly around your body at all times. Avoid wearing thick, bulky clothing. Put the shoulder belt of seat belt across the center of the shoulder and the lap belt close to the body to go over the hips. Strictly prohibit the use of slack and twisted seat belts, and seat belts can not be twisted to wear.

Never use a seat belt for more than one adult, and never use it to secure an additional object or a child. Each seat belt can only be used by one occupant. It's dangerous to wrap a seat belt around a child in the occupant arms.

When wearing a seat belt, ensure that it is not twisted or slack. Otherwise the smooth operation of the belt may be impeded. The buckle release button must face outwards.



Do not allow a baby or infant to be carried on the lap. The force of a crash can increase effective body weight, making it impossible to hold onto the child.

Do not allow foreign matters (particularly sugary food and drinks) to enter the seat belt buckle- such substances may render the buckle inoperative.

If the seat belt has been used in a serious accident, or is seriously worn, or has been cut, or the visual load meter shows that the seat belt is no longer available, or the seat belt is a pretensioning seat belt with the pretensioner triggered, the seat belt assembly must be replaced.

Pregnant women should ask their doctor for advice about the safest way to wear seat belts.

A seat belt must not be altered or modified in any way, since such changes may render the belt ineffective. Do not attempt to dismantle, repair or lubricate the retractor or buckle mechanisms.

Each seat belt is fitted with a retractor. When the seat belt is pulled out slowly, the retractor can ensure that the seat belt is retracted freely. But if the seat belt is pulled out too fast or under a sudden impact (a sudden deceleration, acceleration, sharp turn), the seat belt will be locked. See "Seat belts" in Maintenance and Service section for the specific inspection methods.

Before You Drive

! When the seat belt is not used, be sure to retract the seat belt webbing completely, straighten the webbing and put the tongue in place, and keep the webbing and tongue clean to prevent dust and impurities.

Be careful to avoid the erosion of webbing by polishing agents, oils and chemicals (especially battery acid). It can be cleaned safely with mild soap and water. After wear, erosion or damage of the webbing occurs, the seat belt assembly should be replaced.

The driver seats and front occupant seats of the vehicles of this series can be configured with adjustable non-pretensioning force-limiting seat belts and adjustable dual pretensioning force-limiting seat belts; the 2nd row occupant seats may be configured with non-pretensioning non-force-limiting seat belts and pretensioning force-limiting seat belts; the 3rd row seats may be configured with three-point belts.

! Insert the tongue into the buckle until a distinct click is heard, which indicates the belt is locked.

Seat belt with pretensioner (shoulder belt pretensioner)

In the event of serious collision accident, the pretensioner (integrated into the retractor) will be activated by the sensor, the shoulder belt (1) will be contracted a little immediately to prevent the occupants from moving forward and make them seated securely, so that it improves the function of the seat belt further.

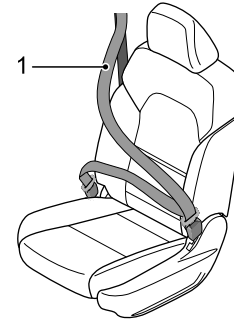

1

Before You Drive

Seat belt with dual pretensioners (shoulder/hip belt pretensioner)

In the event of serious collision accident, the dual pretensioners (one integrated into the retractor, the other integrated into the side lap strap pretensioner) will be activated by the sensor, the shoulder belt (1) and the lap strap (2) will be contracted a little immediately at the same time to prevent the occupants from moving forward and make them seated securely, so that it improves the function of the seat belt further.

Caution

The outer locking tab (3) does not need to be unlocked in the daily use. The outer locking tab (3) should be unlocked by using the special tool, please ask Our Service Dealer to unlock it, if necessary.

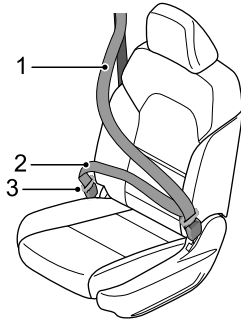

Front seat belt

Fastening

The seat belt is pulled out slowly, passes through the shoulder to be fastened in front of the body, verify that the belt is not twisted or tied, then push the tongue into the buckle until a click is heard.

Loosening

Press the red button on the buckle, then the tongue will pop out under the action of the elastic force. Push the tongue back manually, so that the automatic seat belt retractor can contract the whole seat belt more easily.

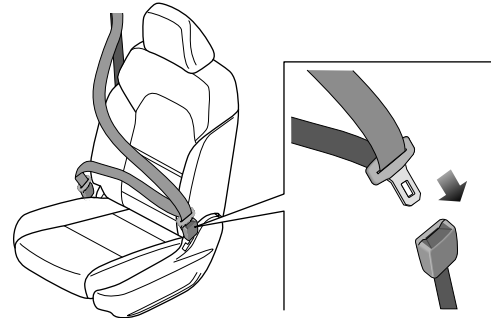

Before You Drive

2nd row seat belts

The fastening and loosening methods for the 2nd row single seat belts are the same as that for front seat belts.

3rd row seat belts

The fastening and loosening methods for the 3rd row single seat belts are the same as that for front seat belts.

The fastening and loosening methods for the 3rd row dual seat belts are the same as that for front seat belts.

The fastening and loosening methods for the seat belts on both sides of the 3rd row triple seat are the same as that for front seat belts.

The middle seat of the 3rd row triple seat uses a roof-mounted seat belt, which is fastened and loosened as follows.

Fastening

Pull the seat belt out of the roof, push the fixed tab (2) into the left buckle, then the movable tab (1) is passed through the abdomen and pushed into the right buckle.

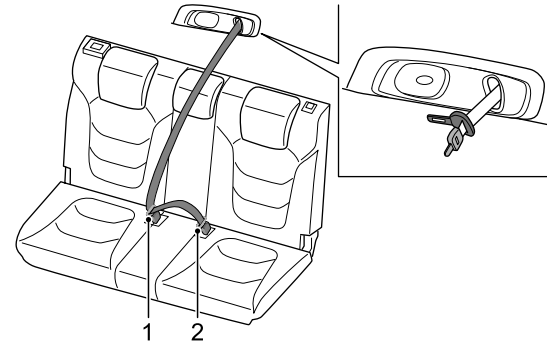

1

Seat belt comfort guide

The seat belt comfort guide is attached to the shoulder belt to keep the shoulder belt away from the head of left occupant.

Take out the guide from the seat backrest pocket.

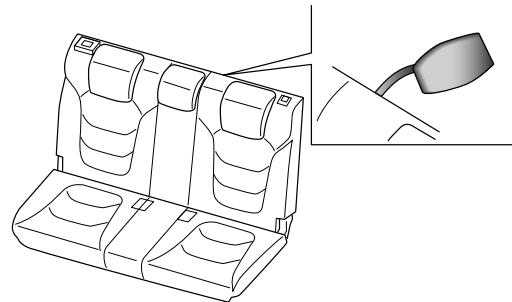

Before You Drive

Place the guide on the shoulder belt, and then insert both sides of the belt into the slot of the guide.

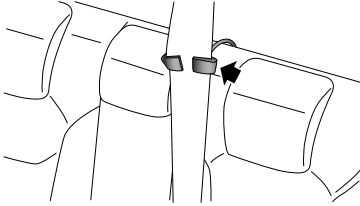

Ensure that the seat belt is smooth, and the guide must be at the upper part of the seat belt.

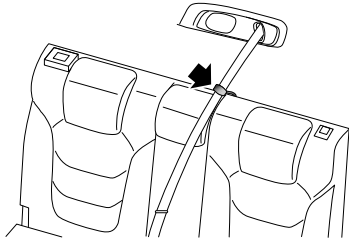

Loosening

To remove the seat belt comfort guide, squeeze both sides of the seat belt together, and remove the seat belt from the guide. Then, put the guide in the seat backrest pocket.

The movable tab (1) is unlocked by pressing the red button on the right buckle.

The fixed tab (2) is pulled out by pressing the red button on the left buckle. Push the tongue back manually, so that the automatic seat belt retractor can contract the whole seat belt more easily.

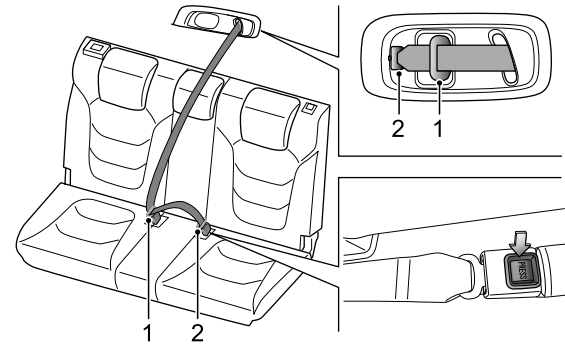

Note: When the seat belt is retracted into the roof, the tongue can be clamped onto the roof.

Before You Drive

Seat belt height adjustment

! Ensure that the slide adjuster is secure after making an adjustment.

Do not adjust the height of the driver seat belt while driving, as the control of vehicle may be lost.

Only the height of the driver seat and front occupant seat belts can be adjusted.

Press the button (1) up and slide the height adjuster on the top of seat belt up and down to suit the height of the occupant. Release the button (1) at the proper position, and pull the seat belt forcibly to ensure that the height adjuster is locked reliably.

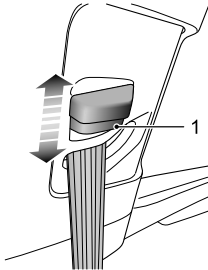

Seat belt warning light

See "Warning lights and indicators" in this section for the specific description of the "Seat belt warning light".

Seat belt pretensioner

! Do not damage or repair a pretensioner. It contains an ignition device, so that any maintenance can only be carried out by Our Service Dealer.

Pretensioners will not function after activation and must be replaced. In the event of a collision, ensure that the pretensioner and all seat belt components have been maintained by Our Service Dealer.

The seat belt pretensioner works together with the airbag to reduce the risk of injury in the event of a head-on collision.

1

Before You Drive

Airbag(s)



No safety system can provide complete protection for personal injury or death in a severe crash. Injuries or death can occur, even if seat belts are worn properly and the airbags are inflated.

After inflation some airbag components are hot - Do NOT touch until they have cooled.

An airbag is inflated with considerable force and can cause facial abrasions and other injuries. These effects can be minimized by ensuring that you and your occupant(s) are wearing seat belts.

The driver seat should be adjusted to be as far rearwards as possible while maintaining the proper control of the vehicle.

Always hold the steering wheel by its rim, so that the airbag can be inflated without obstruction.

Never attach accessory items e.g. a mobile phone bracket, cup holder, cassette tray, etc. to the steering wheel cover or the airbag module cover of the dashboard, or stick/insert anything to an airbag module cover. Otherwise, these objects could interfere with inflation of the airbag, or after the airbag is inflated, they will be propelled into the vehicle to cause injury to occupants.



Do not allow an occupant to obstruct the deployment of the airbag by putting feet, knees, etc. in contact with, or in close proximity to the airbag module cover of the dashboard.

It is forbidden to put the seat cover and other related decorative seat items that affect the deployment of seat airbags on the seats equipped with seat airbags.

Do not modify the seats equipped with seat airbags at will.

Do not paste any sharp objects on A, B, C and D pillars of the vehicle at will, and modify A, B, C and D pillars, so as to avoid injuries to occupants during the operation of airbags.

The seat belt pretensioner works together with the airbag to reduce the risk of injury in the event of a head-on collision.

Do not attempt to remove or pierce the steering wheel, or hit it violently.

Do not allow another person, animal or object to occupy the space between the driver and the deploying range of the airbag. The same applies on the occupant side if an airbag is fitted.

Before You Drive



Do not attempt to maintain the steering wheel, steering column, any airbag system or pretensioner component, or the airbag components with wiring around. Otherwise, it could cause inadvertent activation of the system resulting in personal injury.

Do not modify the front of the vehicle in any way as this could adversely affect airbag deployment.

If the vehicle is to be scrapped, undeployed airbags are potentially dangerous and should be deployed before scrapping. This operation must be done by professional staff.

This vehicle can be equipped with the driver airbag, front occupant airbag, driver side airbag, front occupant side airbag, driver seat far-end side airbag and side air curtain.

Note: Both the airbag and the pretensioner are supplementary protection device, while the seat belt is still the main protection device and must be worn during driving.

Caution

- When an airbag is triggered, a loud noise may be heard and a small amount of smoke-like gas and dust will be released. This smoke does not constitute a health hazard. The dust may be an irritant to the skin and therefore should be washed off with soap and water.
- For safety reasons you are recommended to have the airbag(s) renewed by Our Service Dealer every 10 years. If the vehicle is sold, its owner is obliged to notify the purchaser of the cautions and warnings listed. This obligation is met by handing over these instructions (See Warranty & Service Handbook) to the new owner.

1

Airbag and pretensioner check



After the vehicle is powered on, if the warning light is not turned on or not turned off after about 6 seconds, or turned on when driving, it indicates that the seat belt pretensioner or the airbag is faulty. Contact Our Service Dealer for service as soon as possible.

Each time the vehicle is powered on, the "airbag warning light



(red)" will flash for about 6 seconds, which indicates that the airbag and seat belt pretensioner inspection is in progress; it goes off after flashing for about 6 seconds, which indicates that the airbag and seat belt pretensioner are normal.

Before You Drive

Airbag deployment



Incorrect sitting posture or sitting or resting on the place close to the airbag will result in serious and even fatal injuries when the airbag is deployed.

In order to reduce the injuries caused during the airbag deployment, the seat belt must be always worn properly. The driver and front occupant must have a good sitting posture, and adjust their seat positions to enable them to be far enough away from the front airbag, so as to avoid causing serious injury or death when the airbag is deployed. For vehicles equipped with side airbags and side air curtains, it is also important to ensure that upper extremities are far enough away from the side of the vehicle, avoiding injuries due to airbag deployment.

When the airbag is deployed, children not properly protected may suffer serious injury and even death. Do not hold a child in your arms or put the child on your lap when riding on a vehicle. Do not allow children to ride on a vehicle without protection, and it is prohibited to stick any part of the body out of the window.

The airbag deployment may cause body surface abrasion or bruise or burns due to explosion.



There must be no obstacle in the airbag inflation channel. It is prohibited to place any object between the occupant and the airbag. It is prohibited to fix or place any object on the steering wheel cover or the frontal airbag cover of instrument cluster and its vicinity. It is prohibited to place accessories around the airbag system. If there is obstacle between the occupant and the airbag, the airbag may not be properly inflated, or squeeze the obstacle into the body of occupant, causing serious injury or death.

Do not knock on or crash the airbag or positions of relevant components, to avoid causing serious injury or death due to airbag deployment.

When it is deployed, some airbag components are hot, so do not contact it before cooling down.

In case of crash, airbag control module detects speed change caused by crash to determine airbag deployment. The airbag will deploy instantaneously and powerfully with a loud noise.

When the vehicle is subject to serious front crash, fully deployed airbag along with properly worn seat belt can limit the movement of the driver and the front occupant, thereby reducing the risk of injury to the head and chest. For vehicles equipped with side airbags and side air curtains, if the side of vehicle is seriously crashed, fully deployed side airbag will form an air cushion between the occupant and the side of vehicle, thereby reducing the risk of injury to the side of occupant body.

Before You Drive

When you are sitting upright in the seat and leaning against the seat backrest, the seat belt and the airbag can provide the most effective protection. In case of a serious crash, the airbag deploys violently. At this moment, if you or other occupant does not properly use the seat belt, and tilts the body forward, reclines or has other incorrect posture, the possibility of serious injury or death in an accident will be high.

Caution

- The airbag cannot protect the lower part of occupant body.
- The airbag is not designed for rear collision or slight frontal impact or vehicle overturn, and it does not work during the emergency braking.
- Airbag deployment and contraction are completed in a very short time, and will not provide protection from effects of possible subsequent second impact.
- Upon deployment, the airbag will shrink immediately to ensure the driver could look forward without block.

- Schematic diagram for deployment area of driver and front occupant airbags

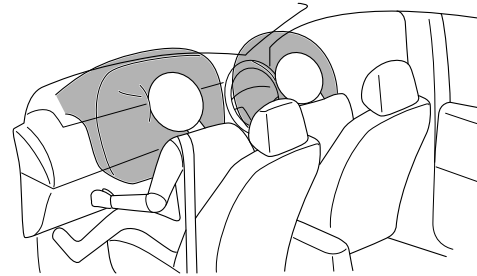

- Schematic diagram for deployment area of side airbags, driver seat far-end side airbag and air curtains

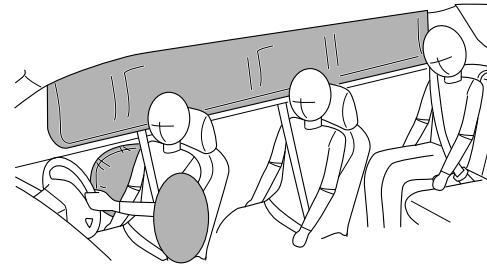

Before You Drive

Frontal airbag

⚠ Do not install the children restraints on the front occupant seat. Frontal airbag deployment will cause serious injury or death to children.

The driver and the front occupant shall not let their feet, knees or other parts of body contact with or get close to the frontal airbag cover

The airbag may deploy in the event of violent jolt or accidental impact to the vehicle chassis. Therefore, be extra careful when driving on a bumpy road, to avoid injuries caused by accidental airbag deployment.

The frontal airbag is designed to deploy in the event of front impact or similar collision. The airbag will deploy under any of the following situations or similar situations.

- Front impact at a relatively high speed with solid wall which cannot move or deform.

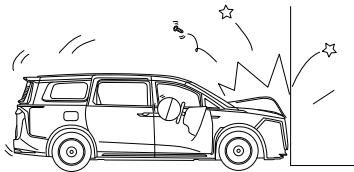

- When the vehicle chassis is seriously damaged. When the vehicle collides with the curbstone, road pavement edge or solid surface, and falls into the deep ditch or deep hole, or violent contact with the ground after vehicle jump may cause serious damage to the chassis.

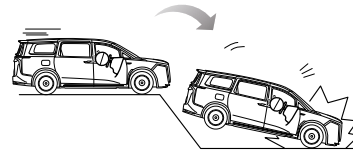
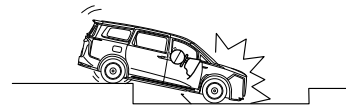
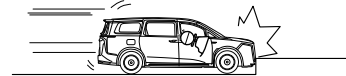

Before You Drive

Side airbag and driver seat far-end side airbag

⚠ The structure and material of seat is critical for the operation of airbag. Therefore, do not install the seat cover, which will affect the deployment of side airbag.

In case of serious side impact, the front seat side airbag on the side subject to impact will pop out from the seat cover and deploy rapidly. The side airbag on the side not subject to impact will not deploy. The side airbag will deploy under any of the following situations or similar situations.

- Side impact occurs between the vehicle and the general occupant car at a relatively high speed.

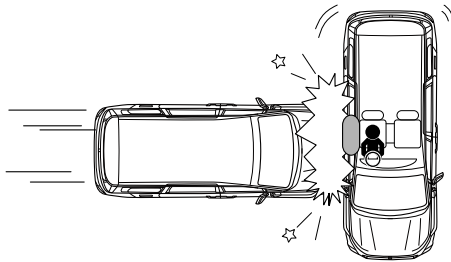

Side air curtain

In case of serious side impact, the side air curtain on the side subject to impact will pop out from the headliner and deploy rapidly. The side air curtain on the side not subject to impact will not deploy. The side air curtain will deploy under any of the following situations or similar situations.

- Side impact occurs between the vehicle and the general occupant car at a relatively high speed.

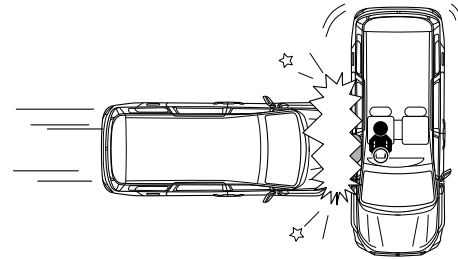

1

Before You Drive

Conditions for airbag undeployment

Airbag will deploy based on the crash object, direction and vehicle deceleration caused by crash rather than vehicle speed. When the impact force of crash is absorbed or dispersed on the vehicle body, the airbag may not deploy; but based on the impact condition during the accident, the airbag may sometimes explode. Therefore, damage severity of vehicle shall not be considered as the judgment of airbag deployment.

Frontal airbag

The side airbag may not deploy under any of the following situations or similar situations.

- When the impact direction deviates from the center of vehicle.
- When front impact occurs with solid electric pole, traffic sign post, trees and other small objects.

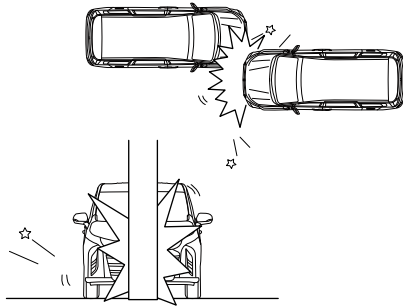

- Impact with lower part of truck tailgate; piercing-type impact with truck or vehicles with higher chassis.
- Front offset impact with guardrail.

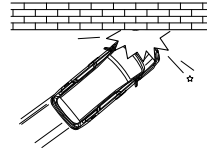
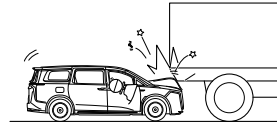

- Side or rear impact.
- Vehicle rollover.

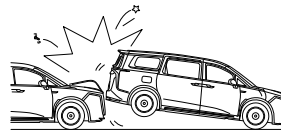

Before You Drive

Side airbag, driver seat far-end side airbag and side air curtain

The side airbag and side air curtain may not deploy under any of the following situations or similar situations.

- Impact at a certain angle with the side.
- Side impact with a two-wheel motorcycle.

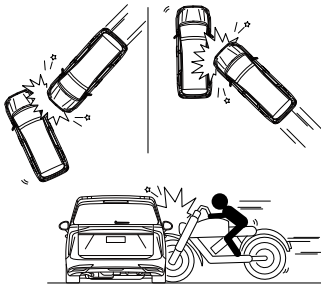

- Side impact with the front compartment of vehicle.
- Side impact with the rear of vehicle.
- Vehicle rollover.

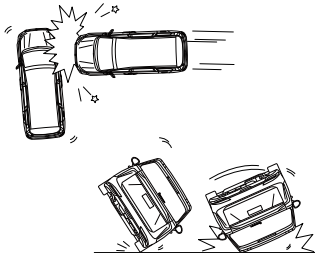

- Front offset impact with guardrail.
- Side impact with a post.

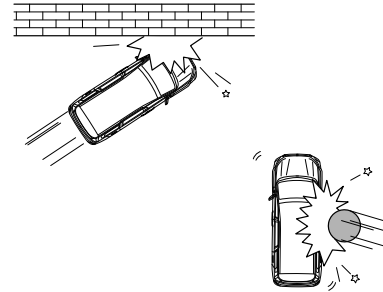

- Front impact with a stationary or moving vehicle.
- Rear impact.



Before You Drive

Replace airbag system components after a collision accident



The airbag system could be damaged due to a collision accident. Thus the airbag system cannot operate normally to protect you and occupants in future collision accidents resulting in serious injury even death. To ensure the airbag system remains valid after a collision accident, consult Our Service Dealer to make inspection and necessary replacement of components.

Once the airbag is inflated, it is required to replace the components of the airbag system. Contact Our Service Dealer for service as soon as possible.

Event data recorder (EDR)

This vehicle is equipped with an event data recorder (EDR). The main function of EDR is to record the data of vehicle movement and safety system status within a short time during collision or near collision, which can be used to reproduce the state of the vehicle before, during and after collision, such as vehicle speed, accelerator pedal opening, and brake pedal depth. The EDR data extraction tool reads data based on the 11-bit CAN identifier, and reads the EDR data by using the 2216 "Reading data service by data identifier" service in 11.2 of ISO 14229-1:2020 by means of physical addressing. The data can be read from the airbag controller with our dedicated after-sales scan tool. You can log in to the corresponding link of our official website to purchase the EDR data reader.

Before You Drive

Child Restraints (not available with the vehicle)

General points relating to child seat

Although one of MAXUS's main criteria when designing your vehicle, the safety of your children also depends on you.

May result in death or serious injury!

Observe the instructions provided by the infant or child restraint device's manufacturer if you are installing or using such device.

WARNING: child restraint anchorages are designed to withstand only those loads imposed by correctly fitted child restraints. Under no circumstances are they to be used for adult seatbelts, harnesses, or for attaching other items or equipment to the vehicle.

For maximum safety, please observe the following recommendations:

- In accordance with regulations, all children under the age of 12 or less than one and a half metres tall must travel in approved child seats suited to their weight, on seats fitted with a seat belt or ISOFIX mountings.
- Statistically, the safest seats in your vehicle for carrying children are the rear seats.
- A child weighing less than 9 kg must travel in the rearward facing position both in the front and in the rear.

 We recommends that children should travel on the rear seats of your vehicle:

- Rearward facing up to the age of 3.
- Forward facing over the age of 3.

Note: The regulations on carrying children are specific to each country. Refer to the legislation in force in your country.

Below are instructions must be followed when using a child seat on the front passenger seat

Rearward facing

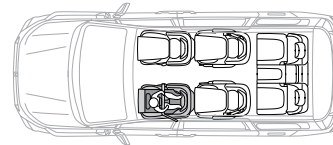

The front passenger airbag must be deactivated when using a rear-facing child seat on the front passenger seat. Once the rear-facing child seat is removed from the front passenger seat, the front passenger airbag must be activated immediately.

If needed, adjust the front passenger seat to its fully rear position to avoid the interaction between the child seat and IP fascia.

Before You Drive

Forward facing

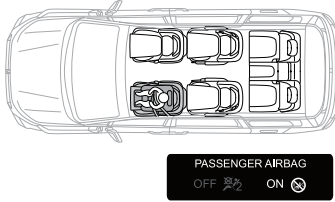

If needed, adjust the front passenger seat to its fully rear position to avoid the interaction between the child seat and IP fascia.

If needed, the front passenger seatback can be adjusted so that there is full support between the child seat and vehicle seat.

! Adjust or remove the head restraint when installing the child seat on the front passenger seat so that the front passenger seat or head restraint provides full support to the child seat.

Ensure that the vehicle seat belt passes through the child seat or occupant without getting tangled or bending.

Note: Refer to the legislation in force in your country before installing a child seat on this seating.

Deactivating the passenger's front airbag

! Never install a rearward facing child restraint system on a seat protected by an active front airbag. This could cause the death of the child or serious injury.

The warning label present on both sides of the passenger's sun visor repeats this advice. In line with current legislation, the following tables contain this warning in all of the languages required.

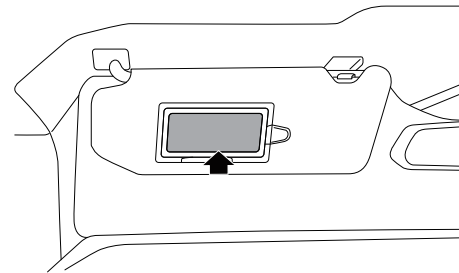

Before You Drive

Below are instructions that must be followed when using a child seat on the rear seats

Rearward facing

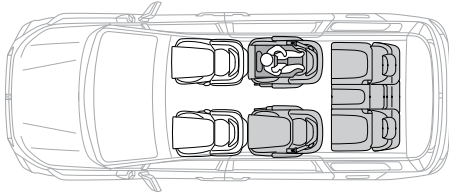

Forward facing

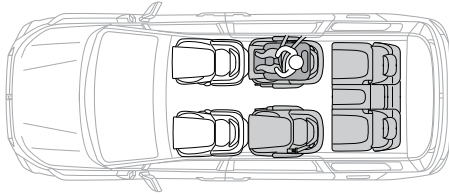

If needed, adjust the second row or third row seat to its fully rear position and its seatback angle when installing the child seat on it.

If needed, adjust any front passenger seat (fore/aft) in case there is an interaction between the child seat/child and the respective front seat.

Adjust or remove the head restraint when installing the child seat so that the passenger seat or head restraint provides full support to the child seat.



Ensure that the vehicle belt passes through the fitting guide attached to the child seat without getting tangled or bending.

Note: A child seat with a support leg must never be installed on the centre rear passenger seat.

Before You Drive

Child seat recommendation

Our company offers a range of recommended child seats.

Mass Group	Recommended child restraint system	Picture	Fixation	
			Fixed with a seat belt	Fixed with lower anchorages
Group 0/0+ Up to 13kg	Maxi Cosi Cabriofix		Yes	Not Applicable
Group 1 9 to 18kg	Römer King II LS		Yes	Not Applicable
Group 2 15 to 25kg	Römer Kidfix 2S		Yes	Yes
Group 3 22 to 36kg	Graco Booster		Yes	Not Applicable

Note: For optimal protection, it is recommended to use this child seat including the back section and lap belt guide element Secure Guard.

Before You Drive

Locations for child seats secured using the seat belt

In accordance with European regulations, this table indicates the options for installing child seats secured using the seat belt and universally approved in relation to the weight of the child and the seat in the vehicle.

Seat		Front passenger airbag	Mass group			
			Group 0/0+ Up to 13kg	Group 1 9 to 18kg	Group 2 15 to 25kg	Group 3 22 to 36kg
Row 1	Passenger seat	Deactivated "OFF"	U	U	U	U
		Activated "ON"	X	UF	UF	UF
Row 2	Both seats		U	U	U	U
Row 3	Outer seats		U	U	U	U
	Centre seat		U	U	U	U

U:seating position suitable for the installation of a child seat secured using the seat belt and approved for universal use rearward facing and/or forward-facing.

UF:seating position suitable for the installation of a child seat secured using the seat belt and approved for universal use forward-facing.

X:seating position not suitable for installing a child seat for the weight group indicated.



Remove and stow the head restraint before installing a child seat with a backrest on a passenger seat. Refit the head restraint once the child seat has been removed.

When installing a CRS on the front passenger seat, the below instructions can be followed if needed:

- **Adjust the front passenger seat to its fully rear position.**
- **Adjust the front passenger seatback to have full support between the child seat and vehicle seat.**

When installing a CRS on the second row or third row seat, the below instructions can be followed if needed:

- **Adjust the second row or third row seat to its fully rear position when installing the child seat on it.**
- **Adjust any front passenger seat (fore/aft) in case there is an interaction between the child seat/child and the respective front seat.**
- **The seatback angle can be adjusted to have full support between the child seat and vehicle seat.**

Before You Drive

"ISOFIX" mountings

Your vehicle has been approved in accordance with the latest ISOFIX regulation.

- The seats, represented below, are fitted with regulation ISOFIX mountings:

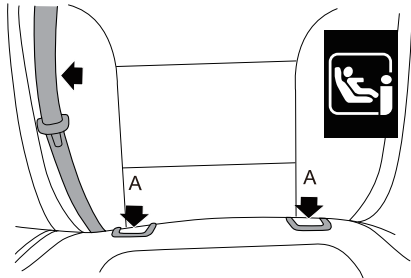
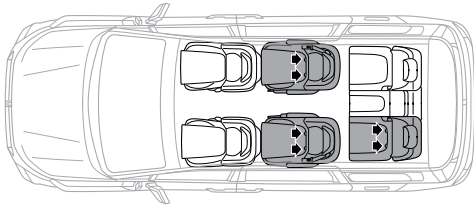

- Two rings A, located between the vehicle seat back and cushion, indicated by a marking.

! For information on the possibilities for installing ISOFIX child seats in your vehicle, refer to the summary table.

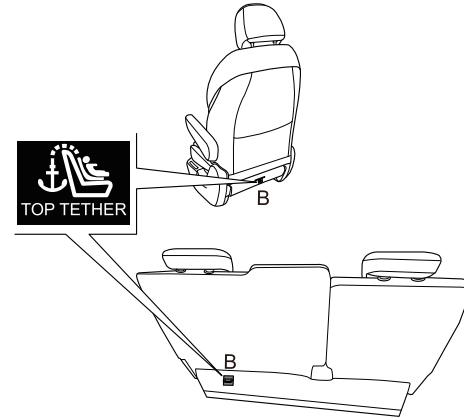

- One ring B behind the seat and identified by a marking, referred to as the Top Tether for fixing the upper strap.

Before You Drive

- This ISOFIX mounting system provides fast, reliable and safe fitting of the child seat in your vehicle.
- The ISOFIX child seats are fitted with two latches which are secured on the two rings A. Some seats also have an upper strap, known as the Top Tether, which is attached to ring B.



Allows for an extension strap to be used, if the length of the CRS strap (in some cases for rearward facing CRS) is not long enough to reach the anchorage.

- To secure the child seat to the TOP TETHER:
 - Remove and stow the head restraint before installing the child seat on the seat (refit it once the child seat has been removed).
 - Pass the upper strap of the child seat behind the seat backrest, between the apertures for the head restraint rods.
 - Fix the hook of the upper strap to the ring B.
 - Tighten the upper strap.



When fitting an ISOFIX child seat to the left-hand of the third row seat, before fitting the seat, first move the center rear seat belt towards the middle of the vehicle, to avoid the seat interfering with the operation of the seat belt.



The incorrect installation of a child seat in a vehicle compromises the child's protection in the event of an accident. Follow strictly the fitting the instructions provided with the child seat.

Before You Drive

Locations for ISOFIX child seats

In line with European regulations, this table indicates the options for installing ISOFIX child seats on seats in the vehicle fitted with ISOFIX mountings.

Seat		Front passenger airbag	Mass group			
			Group 0/0+ Up to 13kg	Group 1 9 to 18kg	Group 2 15 to 25kg	Group 3 22 to 36kg
Row 1	Passenger seat	Deactivated "OFF"	X			
		Activated "ON"	X			
Row 2	Both seats		IL	IL	IL	IUF/IL
Row 3	Left outer seat		IL	IL	IL	IUF/IL
	Right outer seat		X			
	Centre seat		X			

IUF:seating position suitable for the installation of an Isofix Universal seat, forward facing secured using the upper strap.

IL:seating position suitable for the installation of an Isofix Sem-Universal seat either:

- Rearward facing fitted with an upper strap or a support leg.
- Forward facing fitted with a support leg.
- A cot fitted with an upper strap or a support leg.

For securing the upper strap using the ISOFIX mountings, refer to the corresponding section.

X:seating position is not suitable for the installation of an ISOFIX seat or a cot of the weight group indicated.



Remove and stow the head restraint before installing a child seat with a backrest on the passenger seat. Refit the head restraint once the child seat has been removed. When installing the child seat, the below instructions can be followed if needed:

- **Adjust the second row or third row seat to its fully rear position when installing the child seat on it.**
- **Adjust any front passenger seat (fore/aft) in case there is an interaction between the child seat/child and the respective front seat.**
- **The seatback angle can be adjusted to have full support between the child seat and vehicle seat.**

Before You Drive

Locations for i-Size child seats

The i-Size child seats have two latches that engage on the two rings A. The i-Size child seats also have:

- Either an upper strap which is attached to the ring B.
- Or a support leg which sits on the vehicle's floor, compatible with the seat approved for i-Size.

The role of which is to prevent the child seat from tipping forward in the event of a collision.

For more information on ISOFIX mountings, refer to the corresponding section.

In accordance with the new European regulations, this table indicates the options for installing i-Size child seats on seats in the vehicle fitted with ISOFIX mountings approved for i-Size.

Seating position		Front passenger airbag	i-Size restraint system
Row 1	Passenger seat	Deactivated "OFF"	X
		Activated "ON"	X
Row 2	Both seats		i-U
Row 3	Left outer seat		i-U
	Right outer seat		X
	Centre seat		X

i-U:suitable for i-Size restraints of the "universal" category, forward facing or rearward facing.

i-UF:only suitable for i-Size restraint systems in the "Universal" category, forward facing.

X:seating position not suitable for i-Size restraint systems in the "Universal" category.



Remove and stow the head restraint before installing a child seat with a backrest on the passenger seat. Refit the head restraint once the child seat has been removed. When installing the child seat, the below instructions can be followed if needed:

- **Adjust the second row or third row seat to its fully rear position when installing the child seat on it.**
- **Adjust any front passenger seat (fore/aft) in case there is an interaction between the child seat/child and the respective front seat.**
- **The seatback angle can be adjusted to have full support between the child seat and vehicle seat.**

Before You Drive

Instruments and controls

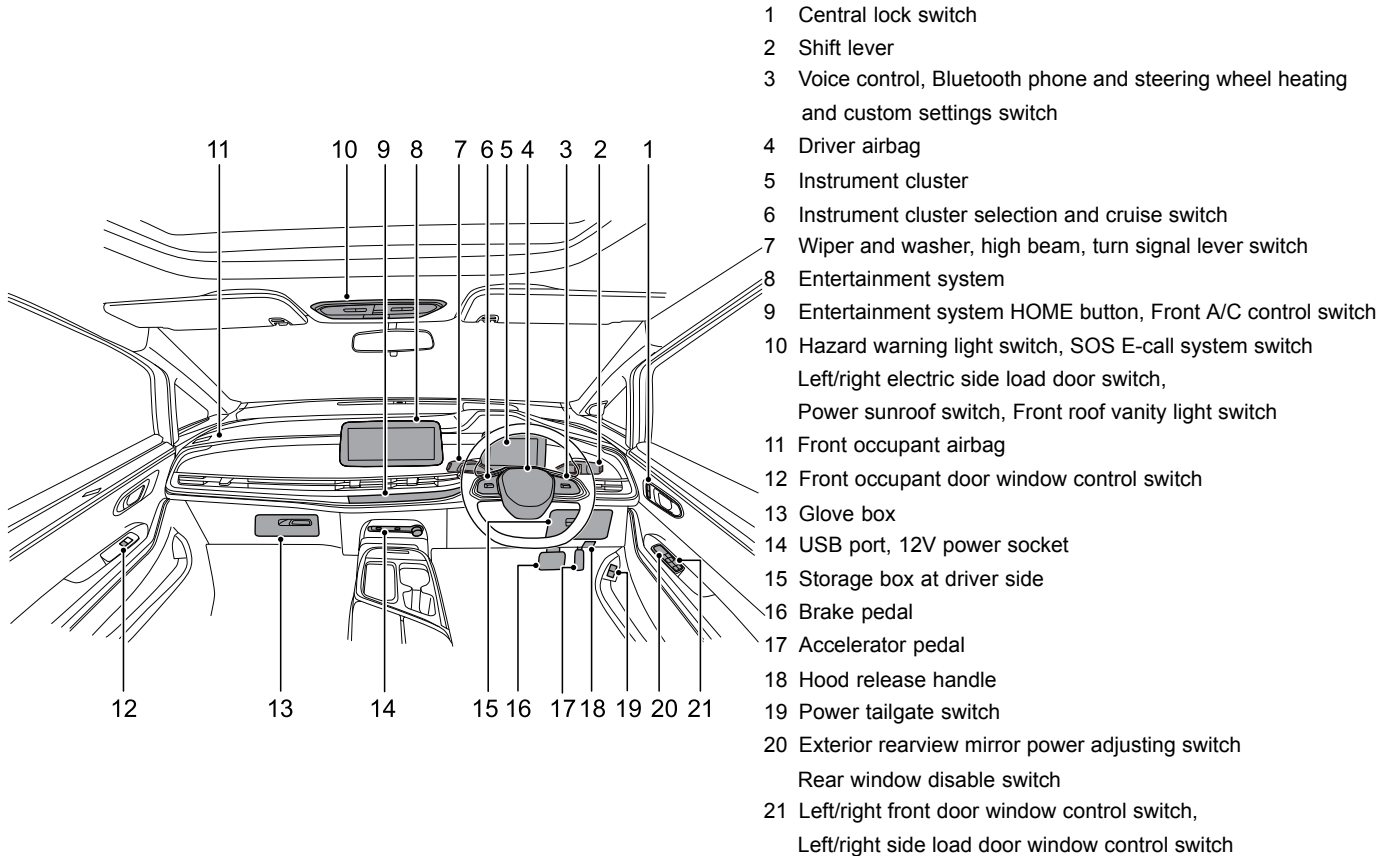

Before You Drive

Instrument cluster

Miles of instrument cluster

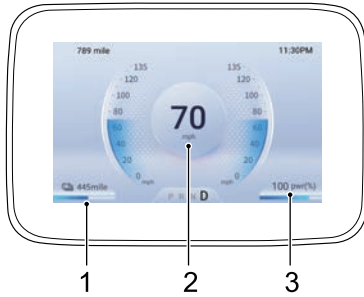

Kilometres of instrument cluster

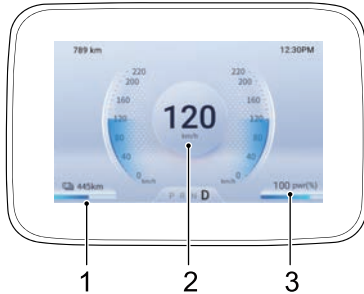

- 1 Voltmeter of high-voltage battery pack
- 2 Speedometer
- 3 Power meter

Caution

Don't place any object in front of the instrument cluster to avoid shielding dial and warning light.

1

Voltmeter of high-voltage battery pack

The state of voltmeter of high-voltage battery pack will be indicated based on the proportion of ignited battery icons. When the electric quantity of the battery is too low, the red strip-type bar will light up, and "warning lamp of high-voltage battery pack for low electric quantity (yellow)" will also light up.

Note: Low electric quantity of high-voltage battery pack will make some functions of the vehicle lose effect.

Caution

When the electric quantity of high-voltage battery pack is low, the battery will be charged as soon as possible.

Ensure enough electric quantity is stored in high-voltage battery pack before running.

After the vehicle is fully charged, Battery Management System will have automatic calibration function. After the vehicle has been shallowly charged (less than 99%) every two to three times, the vehicle needs to be fully charged for once (100%).

Before You Drive

Speedometer

The speedometer indicates the current road speed in miles per hour or in kilometers per hour.

Power meter

The power meter shows the power percentage of power system. Power indication range is 25-100%, and the maximum and minimum will be shown if they are exceeded.

Note: For vehicles with instrument cluster (Type II), the power meter is located on the power consumption/energy recovery interface. You can short press the selection switch on the instrument cluster to the left and right  to switch to the power consumption/energy recovery interface.

Caution

The power meter indicates the power percentage, not the calculated actual power.

Message center

Miles of instrument cluster

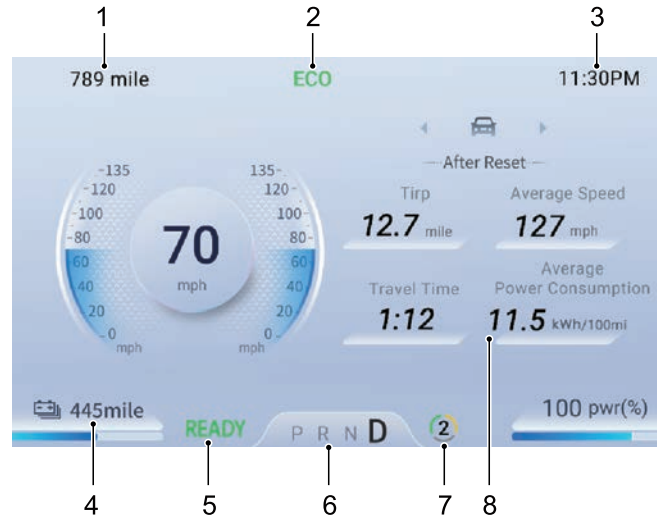

Before You Drive

Kilometres of instrument cluster



- 1 Total mileage
- 2 Driving mode
It displays the current driving mode of the vehicle: ECO (economy mode) and SPORT (sport mode). The driving mode can be switched by the driving mode switch on the central control screen.
- 3 Current time
- 4 Driving mileage

It displays the estimated mileage that the vehicle can run before the electric quantity of high-voltage battery is used up.

- 5 Power system status
- 6 Gear display
- 7 Energy recovery level

It indicates the energy recovery level of current vehicle, and the energy recovery level is divided into three levels of high, medium and low, which are numerically displayed on the instrument pack as 3, 2 and 1. High-level energy recovery is larger than the medium-level energy recovery, while the medium-level energy recovery is larger than the low-level energy recovery. The energy recovery level can be switched through energy recovery switch on the central control screen.

- 8 Simple interface, ADAS (Advanced Driver Assistance System) interface (if available on your vehicle), trip computer interface, fault inquiry interface



Short press the selection switch  on the instrument cluster to the left and right to switch between the following interfaces: Simple interface→ADAS (Advanced Driver Assistance System) interface→Trip computer interface→Fault inquiry interface (if in fault)→Simple interface.

Before You Drive

Note: If the vehicle is not equipped with the relevant function, the interface will not be displayed.

Trip computer interface

Short press up and down the selection switch  on the instrument cluster to switch between the following interface contents:

- Instantaneous power consumption

It displays the instantaneous power consumption when the battery is working.

- After self-activated (if available on your vehicle),

it displays the trip, average speed, driving time and average power consumption since the vehicle is powered on to start.

- After self-reset (if available on your vehicle),

it displays the trip, average speed, driving time and average power consumption since the last reset.

In this interface, long press the instrument cluster selection

switch  to reset the trip, average speed, driving time and average power consumption.

In this interface, when —.- is displayed for the trip on the instrument cluster, please long press it to  reset.

- Tire pressure monitoring (if available on your vehicle)

In normal mode, it displays the current tire pressure in real time.

Note: For vehicles configured with tire pressure monitoring system, when the vehicle is in stationary state and inflation and deflation operations are conducted for tires, if the pressure for inflation or deflation is larger than 8 kPa, the tire pressure information display value on the instrument cluster will be automatically updated.

- Battery voltage (if available on your vehicle),
It displays the current battery voltage value.
- Remaining maintenance mileage (if available on your vehicle)
This message reminds you of the remaining mileage of your vehicle before the next maintenance.

ADAS (Advanced Driver Assistance System) interface (if available on your vehicle)

It displays the relevant information of driver assistance system configured on your vehicle.

- Collision warning and assist
- Lane departure warning
- Lane keeping assist
- Adaptive cruise
- Integrated cruise assist
- Speed limit information function
- Intelligent speed limit assist
- Blind spot assist

Fault inquiry interface

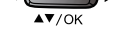
Short press up and down the selection switch  on the instrument cluster to switch between the following interfaces: the relevant fault messages for vehicle warning can be inquired on this interface (if no fault, the interface will not be displayed).

Alarm messages

Most of alarm messages will have a corresponding graphic and text description in the instrument cluster. The warning light will illuminate to display messages.

If more than one alarm message is activated, the alarm messages will be displayed in a cycle by priority, and each alarm message will be displayed for 3 seconds.

The priority for alarm message is higher than that for trip computer message, and after the vehicle is powered on, the alarm message will be displayed by priority.

Please operate in strict accordance with the instructions in the alarm message. If there is relevant instructions, please stop the vehicle for inspection or consult our authorized service provider.

Important alarm messages

The currently displayed important alarm message can be temporarily shielded by short pressing the instrument cluster

selection switch  or automatically shielded 9 seconds later. It can also be viewed in the alarm query interface if the alarm is not canceled.

If all the alarm messages are shielded, the trip computer message will be displayed normally.

When the conditions of alarm activation are canceled, the corresponding alarm messages are also canceled to display.

Before You Drive

Indicative messages

Indicative messages disappear automatically after 3 seconds.

Caution

Don't neglect the alarm messages, otherwise it may cause serious damage to the vehicle. If the alarm indicator is on, please stop the vehicle as soon as possible if it is safe to do so.

Service interface reminders

Next maintenance reminder

When the message center of instrument cluster displays “XXmile remained before the next maintenance” or “XXkm remained before the next maintenance”, it reminds you of the remaining mileage of your vehicle before the next maintenance.

Imminent maintenance reminder

When the message center of instrument cluster displays “Maintenance period is imminent, please make maintenance as soon as possible”, it reminds you to go to our authorized service provider for maintenance as soon as possible.

Service now reminder

When the message center of instrument cluster displays “Please make service now”, it reminds you that the vehicle needs service now and you should go to our authorized service provider for maintenance as soon as possible.

Maintenance overdue reminder

When the message center of instrument cluster displays “Maintenance is overdue, please make immediate maintenance”, it reminds you that the vehicle maintenance is overdue and you should go to our authorized service provider for maintenance immediately.

Tire pressure monitoring system

The tire pressure monitoring system automatically monitors the tire conditions in real time, providing effective safety guarantee for driving.

When the tire pressure is insufficient, too high, or the tire leaks quickly or the system fails in the course of driving, the

"TMPS warning light (yellow)"  on the instrument cluster illuminates with voice prompt, and the instrument display shows the corresponding alarm interface.

Warning lights and indicators

Direction indicator



The left or right "direction indicators (green)" flash when making a turn. When the hazard warning light switch is pressed, the left and right direction indicators flash simultaneously.

Note: If a direction indicator flashes rapidly, it indicates that the bulb in this direction indicator is faulty.

Headlight high beam indicator



The "headlight main beam indicator (blue)" illuminates when the headlights are on main beam or flash on.

IHC (Intelligent High Beam Control) indicator

Note: It applies to vehicles configured with IHC.



With the vehicle powered on, when IHC system controls the high beam to illuminate, "IHC indicator (blue)" illuminates; when IHC system controls the high beam to go out, "IHC indicator (grey)" illuminates. See "IHC (Intelligent High Beam Control)" in the Starting and Driving section for more information.

Before You Drive

Rear fog light indicator



The "rear fog light indicator (yellow)" illuminates when the rear fog lights are on.

Position light indicator



The "position light indicator (green)" illuminates when the position lights are on.

IMMO warning light



With the vehicle powered on, if the immobilizer authentication is successful, the "IMMO warning light (yellow)" will go out and the vehicle can be started.

If the "IMMO warning light (yellow)" flashes, it indicates that the immobilizer control system is faulty, and the vehicle cannot be started. Please contact our authorized service provider for service immediately.

TPMS warning light



With the vehicle powered on, when the TPMS breaks down, the "TPMS warning light (yellow)" will illuminate. Please contact our authorized service provider for service.

Battery charging indicator



With the vehicle powered on, the "battery charging indicator (red)" illuminates, and goes out after the vehicle is started.

Caution

If the warning light stays on after the vehicle is started or illuminates during driving, it indicates that the charging system has a malfunction, please contact our authorized service provider for service as soon as possible.

READY indicator



This light is used to indicate that the vehicle is ready for running. After the vehicle is started, the "READY indicator (green)" will illuminate and will not go out in the running process.

Charging connection indicator



After charging handle is connected to charging interface, the "charging connection indicator (red)" will illuminate.

Charging status indicator



When the high-voltage battery pack is being charged, the “Charging status indicator (yellow)” will illuminate. When the high-voltage battery pack has been charged, this indicator will go out.

Note: *If the “charging status indicator (yellow)” flashes, it means that battery is faulty and it cannot be charged. Contact our authorized service provider for service as soon as possible.*

Power system fault warning light



With the vehicle powered on, if the power system breaks down, the “power system fault warning light” will illuminate. Please contact our authorized service provider for service.

Warning light of high-voltage battery pack for low electric quantity



With the vehicle powered on, if the “warning light of high-voltage battery pack for low electric quantity (yellow)” illuminates, it means that electric quantity of high voltage battery pack is too low and it need be charged as soon as possible. You shall supplement electric quantity before lighting this light.

Note: *If the warning light illuminates, it means that speed limit function of the vehicle has been started. Vehicle speed will be reduced with decrease of electric quantity of the battery until it is stopped.*

Insulation fault warning light



With the vehicle powered on, if the “insulation fault warning light (red)” illuminates, it means that the vehicle has insulation fault.

Power-limit Indicator



In normal driving state, the “power-limit indicator (yellow)” keeps off. When the “Limited Power Indicator (yellow)” illuminates, the power of the vehicle will be limited and the acceleration performance will be significantly weakened. Contact our authorized service provider for a check as soon as possible.

Airbag warning light



With the vehicle powered on, if the “insulation fault warning light (red)” illuminates, it means that the vehicle has insulation fault. Contact our authorized service provider for service as soon as possible.

Seat belt warning light

Note: *This vehicle can be equipped with rear row seat belt unfastened warning functions, which shall be subject to the actual configuration of the vehicle you purchased.*



With the vehicle powered on, if the driver seat belt is not correctly fastened, the "seat belt warning light (red)" will illuminate. When the speed is higher than 22 km/h, if the driver seat belt is not correctly fastened, the instrument cluster will activate a seat-belt-unfastened audible warning, and the "seat belt warning light (red)" will flash for about 90 seconds. When the seat belt is fastened, the "seat belt warning light (red)" goes out and the audible warning stops. When the vehicle is in reverse gear or the speed is lower than 10 km/h, if the driver seat belt is not correctly fastened, the instrument cluster will not activate any audible warning, while the "seat belt warning light (red)" will illuminate. When the seat belt is fastened, the "seat belt warning light (red)" goes out.

With the vehicle powered on, if the front passenger seat belt is not correctly fastened, the "seat belt warning light (red)" will illuminate. When the speed is higher than 22 km/h, if the front passenger seat belt is not correctly fastened, the instrument cluster will activate a seat-belt-unfastened audible warning, and the "seat belt warning light (red)" will flash for about 90 seconds. When the seat belt is fastened, the "seat belt warning light (red)" goes out and the audible warning stops. When the vehicle is in reverse gear or the speed is lower than 10 km/h,

if the front passenger seat belt is not correctly fastened, the instrument cluster will not activate any audible warning, while the "seat belt warning light (red)" will illuminate. When the seat belt is fastened, the "seat belt warning light (red)" goes out.

When the passenger seat belt (equipped with rear row passenger seat belt unfastened warning function) is not fastened properly, the "seat belt warning light (red)" illuminates. When the speed is higher than 22 km/h and the passenger seat belt (equipped with the rear row passenger seat belt unfastened warning function) is not properly fastened, the instrument cluster activates a seat-belt-unfastened audible warning, and the "seat belt warning light (red)" flashes for about 90 seconds and there is seat map showing the specific unfastened seat. When the passenger seat belt (equipped with the rear row passenger seat belt unfastened warning function) is fastened properly, the "seat belt warning light (red)" goes out and the audible warning stops. When the speed is lower than 10 km/h and the passenger seat belt (equipped with the rear row passenger seat belt unfastened warning function) is not properly fastened, the "seat belt warning light (red)" illuminates. When the passenger seat belt (equipped with the rear row passenger seat belt unfastened warning function) is fastened properly, the "seat belt warning light (red)" goes out.

Note: *Opening the door will reset the time when the seat belt warning light flashes. Front passenger and rear row passenger seat belt unfastened warning function can only be triggered when there is passenger on the seat.*

Brake system warning light



With the vehicle powered on, if the brake fluid level is abnormal or the brake system breaks down, the "brake system warning light (red)" will illuminate. Please immediately stop the vehicle safely, and contact our authorized service provider for service as soon as possible.

ABS (Anti-lock Braking System) warning light



With the vehicle powered on, if the "ABS warning light (yellow)" illuminates while driving, it indicates that the ABS is faulty. Please contact our authorized service provider for service as soon as possible.

EBD (Electronic Brake Distribution) warning light



With the vehicle powered on, if the "EBD warning light (red)" illuminates while driving, it indicates that the brake system is faulty. Please contact our authorized service provider for service as soon as possible.

ESC (Electronic Stability Control) indicator



With the vehicle powered on, the "ESC indicator (yellow)" flashes when the ESC is operating. If the indicator

illuminates, it indicates that the electronic stability control system is faulty, please contact our authorized service provider for service as soon as possible.

ESC (Electronic Stability Control) OFF indicator



With the vehicle powered on, if the ESC OFF switch is pressed to disable the ESC function, the "ESC OFF indicator (yellow)" will illuminate.

See "Brake System" in the Starting and Driving section for more information.

EPB (Electronic Parking Brake) indicator



With the vehicle powered on and the EPB enabled, when the parking brake is applied, the "EPB indicator (red)" will illuminate and immediately go out after the parking brake is fully released.

EPB (Electronic Parking Brake) malfunction indicator



With the vehicle powered on, if the "EPB malfunction indicator (yellow)" illuminates, the brake system is faulty. Please immediately stop the vehicle safely, and contact our authorized service provider for service as soon as possible.

Before You Drive

See “Brake System” in the Starting and Driving section for more information.

AUTO HOLD indicator

A black square icon with the words "AUTO HOLD" in white, stacked vertically.

With the vehicle powered on and the AUTO HOLD enabled, the "AUTO HOLD indicator (grey)" will illuminate; when the AUTO HOLD is activated, the "AUTO HOLD indicator (green)" will illuminate.

AUTO HOLD has memory capacity. When the AUTO HOLD function is turned on and the driver unfastens the seat belt, the "AUTO HOLD indicator (grey)" will go out, but the function ON state is still memorized by the AUTO HOLD system. In this case, please fasten the seat belt again to enable the AUTO HOLD function.

With the vehicle powered on and the AUTO HOLD enabled, when the AUTO HOLD function is faulty, the "AUTO HOLD indicator (yellow)" will illuminate.

See “Brake System” in the Starting and Driving section for more information.

HDC (Hill Descent Control) indicator



With the vehicle powered on and the HDC enabled, the "HDC indicator (green)" illuminates. When HDC is activated, the "HDC indicator (green)" flashes.

With the vehicle powered, when the HDC function is faulty, the "HDC indicator (yellow)" will illuminate.

See “Brake System” in the Starting and Driving section for more information.

EPS (Electric Power Steering) system malfunction warning light



With the vehicle powered on, if the "EPS system malfunction warning light (yellow)" illuminates, it indicates that the electric power steering system is in general failure, with the performance decreased, please stop the vehicle as soon as safety permits. If the light stays on after restarting the vehicle and driving for a short moment, please contact our authorized service provider for service as soon as possible; if the "EPS system malfunction warning light (red)" illuminates, it indicates that the electric power steering system is in serious failure, please immediately stop the vehicle safely, and contact our authorized service provider for service as soon as possible.

FCW (Forward Collision Warning) warning light/AEB (Automatic Emergency Braking) warning light

Note: *It applies to vehicles configured with FCW and AEB.*



With the vehicle powered on, if the FCW/AEB function is not enabled or is faulty, the "FCW/AEB warning light (yellow)" illuminates; if the FCW/AEB function is enabled, the warning light will not illuminate. If the FCW system gives an alarm, the "FCW/AEB warning light (yellow)" flashes; if the AEB function is triggered, the "FCW/AEB warning light (red)" flashes.

See "FCW (Forward Collision Warning) and AEB (Automatic Emergency Braking)" in the Starting and Driving section for more description.

LDW (Lane Departure Warning)/LKA (Lane Keep Assist) /ELK (Emergency Lane Keeping) warning light

Note: It applies to the vehicles with LDW, LKA and ELK.



With the vehicle powered on, when LDW, LKA and ELK are operating, the "LDW warning light/LKA warning light /ELK warning light (grey)" illuminates.

When LDW, LKA and ELK give an alarm or are triggered, the "LDW warning light/LKA warning light /ELK warning light (yellow)" illuminates.

When LDW, LKA and ELK are disabled, the "LDW warning light/LKA warning light /ELK warning light (yellow)" illuminates.

If the warning light illuminates in yellow when LDW, LKA and ELK are enabled, it indicates that the LDW, LKA and ELK break

down. Please contact our authorized service provider for service as soon as possible.

See "LDW (Lane Departure Warning)/LKA (Lane Keep Assist) /ELK (Emergency Lane Keeping)" in the Starting and Driving section for more description of their functions.

ACC (Adaptive Cruise Control) indicators

Note: It applies to vehicles configured with ACC.



With the vehicle powered on, if the ACC system is in standby mode, the "ACC indicator (grey)"

illuminates ; with the ACC enabled, if the ACC system meets the activation conditions, the "ACC indicator (blue)"



illuminates.

See "ACC (Adaptive Cruise Control)" in the Starting and Driving section for more description of cruise function.

ICA (Integrated Cruise Assist) indicators

Note: It applies to vehicles configured with ICA.



With the vehicle powered on and ICA enabled, when the ICA is activated, the "ICA indicator (blue)" illuminates. If ICA is in standby mode, the "ICA indicator (grey)" illuminates.

Before You Drive

See “ICA (Integrated Cruise Assist)” in the Starting and Driving section for more description of cruise function.

SLIF (Speed Limit Information Function) indicators

Note: *It applies to vehicles configured with SLIF system.*



With the vehicle powered on, when a traffic sign is detected, the “SLIF indicator” illuminates. See “SLIF (Speed Limit Information Function)” in the Starting and Driving section for more information.

ISA (Intelligent Speed Limit Assist) indicators

Note: *It applies to vehicles configured with ISA.*



With the vehicle powered on, when a traffic sign is detected, the “ISA indicator” illuminates. Please slow down to avoid overspeed driving. See “ISA (Intelligent Speed Limit Assist)” in the Starting and Driving section for more information.

ECO indicator



With the vehicle powered on, if the ECO switch is pressed, the “ECO indicator (green)” will illuminate.

SPORT indicator



With the vehicle powered on, if the SPORT switch is pressed, the “SPORT indicator (red)” will illuminate.

Speed limit indicator

Note: *It applies to vehicles configured with speed limit indicator.*



With the vehicle powered on, when the vehicle speed limit function is enabled, the “speed limit indicator (yellow)” illuminates with sound alarm. When the vehicle speed limit function is disabled, the “speed limit indicator (yellow)” goes out and the sound alarm stops.

Trailer indicator

Note: *It applies to vehicles configured with trailer indicator.*



With the vehicle powered on, if the trailer is connected successfully, when the turn signal lamp is turned on, “trailer indicator (green)” on the instrument cluster flashes. When the trailer connection fails, “trailer indicator (green)” on the instrument cluster goes off.

Exterior light switch

Combination light control switch

Light control switch

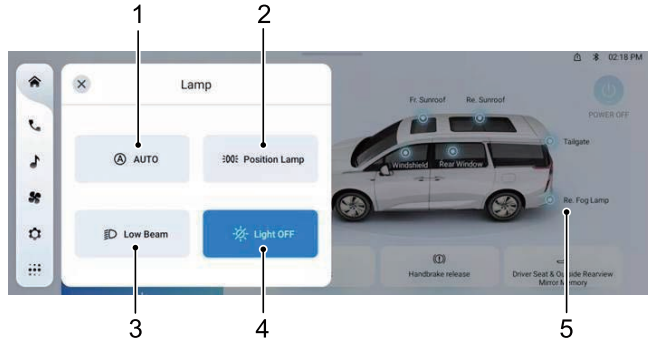

The light control switch is on the central control screen. Please operate it through the touch keys on the central control screen. Click the lamp touch button, and the corresponding lamp will light up. The daytime running lights automatically illuminate after the vehicle is started.

- 1 **AUTO**: Headlight control switch. Press **AUTO** switch, and the headlights successively switch between **AUTO**(Headlights automatically adjust) → **Position Lamp** → **Low Beam** → **Light OFF** positions.

When the headlight switch is in **AUTO** position, the headlights turn on or off according to the ambient lighting.

The daytime running lights automatically illuminate when other lights are not lit after the vehicle is started.

- 2 **Position Lamp**: Position lamps switch. When the headlight switch is in **Position Lamp** position, the following lights illuminate:
 - Position lights
 - License plate lights
 - Dashboard lights
- 3 **Low Beam**: Headlights low beam switch.



Note: If headlights are on when the vehicle is parked, the battery will discharge, and the vehicle may be unable to restart due to battery lack of power. An audible warning will sound if the headlight switch is on when the vehicle is powered off.

Note: Before the vehicle is powered off, if the headlight control switch is in **AUTO** position, the headlight control switch is still in **AUTO** position after the vehicle is powered on again.

Note: Before the vehicle is powered off, if the headlight control switch is not in **AUTO** position, the headlight control switch is in **Light OFF** position after the vehicle is powered on again.

Note: See "Switches on steering column and steering wheel" in this section for more operation methods of turn signals and headlights.

Before You Drive

- 4  Light OFF: Light off switch. Click the Light OFF switch to turn off the light.
- 5 Re.Fog Lamp: Rear fog light switch. When the vehicle is powered on, the headlight control switch is in High Beam or  Low Beam position, and press Re.Fog Lamp switch to turn on the rear fog lights. When the headlight control switch is in  AUTO position, and Re.Fog Lamp switch is turned on, the rear fog lights illuminate or go out along with the headlights according to ambient lighting. When the rear fog lights are turned on, the "rear fog light indicator (yellow)" on the instrument cluster illuminates.

Note: Rear fog lights shall not be used until the visibility is obviously restricted (such as heavy fog or snow).

Daytime running light

Daytime running lights make it easier for others to see the front of your vehicle clearly during the day.

If your vehicle is equipped with daytime running lights, the daytime running lights will illuminate when the vehicle is powered on. The low beam, taillights, position lights, and other lights do not illuminate when the daytime running lights are on. When the vehicle is powered off, the daytime running lights will go out. Comply with ECE R87 regulatory requirements for daytime running lights.

AFS (Adaptive Front Lighting System)

If your vehicle is configured with AFS, the system will automatically adjust the headlight leveling according to the vehicle speed, vehicle load and climbing capacity.

When the vehicle is carrying occupants or luggages, the headlight beam will be automatically adjusted upward or downward.

Note: Headlight beam-focusing is extremely important for safe driving. In case of any failure in the AFS, please contact Our Service Dealer for service as soon as possible.

Before You Drive

Hazard warning light switch

Press the hazard warning light switch  to activate all the turn signals simultaneously, and the "direction indicator (green)" in the instrument cluster will illuminate and flash. Press the switch again to turn off the above lights.

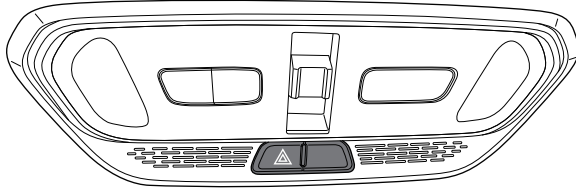

Note: Turn on hazard warning lights to prompt other vehicles that your vehicle has a malfunction and approaching your vehicle may be dangerous.

SOS E-call system switch

Note: It applies to vehicles configured with SOS E-call system switch. 1

In case of emergency, press the SOS E-call system switch, to send signals to the monitoring platform, which can carry out subsequent rescue work.

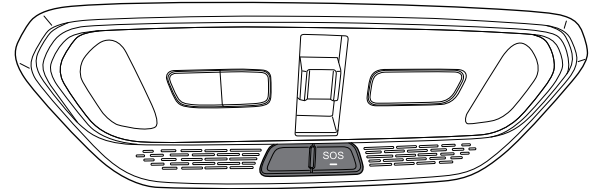

Caution

This switch is for emergency use only, please do not operate it without permission.

Before You Drive

Switches on steering column and steering wheel

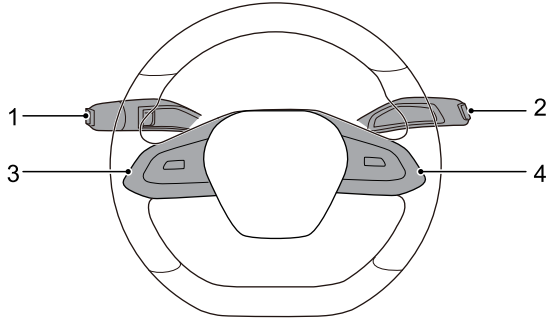

- 1 Wiper and washer, high beam, turn signal lever switch
- 2 Shift lever
- 3 Instrument cluster selection and cruise switch
- 4 Voice control, Bluetooth phone and custom settings switch

Wiper and washer lever switches Front windshield wiper and washer

Type 1

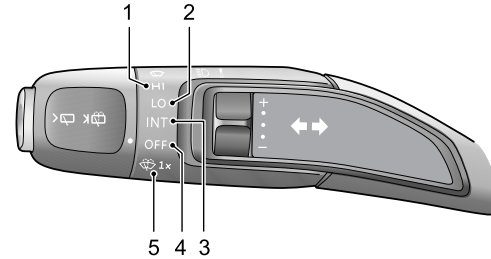

Type 2

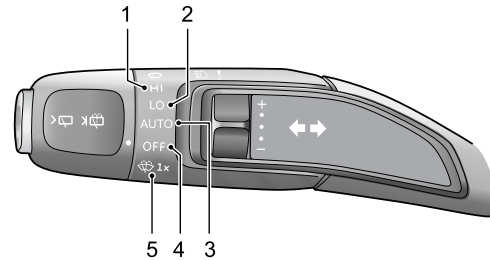

Before You Drive

Rotate the lever switch to the desired position.

Position 1–HI: high-speed wipe.

Position 2–LO: low-speed wipe.

Position 3 (type 1)–INT: intermittent wipe.

Position 3 (type 2)–AUTO: automatic intermittent wipe. The rain sensor detects the rainfall on the windshield and automatically adjusts the wiping frequency of windshield wipers.

Note: Always keep the rain sensor free of dust, dirt or ice.

Position 4–OFF: wiper off.

Position 5— 1x: Washers. Turn the lever switch to the position. The washer will operate immediately. After a short interval, the wiper will operate with the washer. The washer will be off when the lever switch is released.

Note: The wipers will continue to operate for 3 consecutive wipes after the lever switch is released, and operate for 1 wipe after 3 consecutive wipes.

Intermittent wipe/variable interval

 **Worn wiper blades may not clear the windshield properly, thus reducing forward visibility and resulting in accident. Always renew worn wiper blades immediately.**

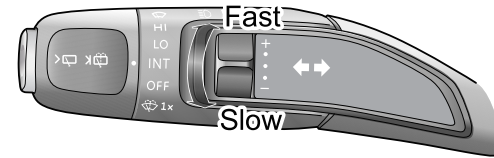

When the lever switch is in INT (intermittent wipe) (front windshield wiper and washer type 1) position, move the switch up and down to vary the interval between wipes.

When the lever switch is in AUTO (automatic intermittent wipe) (front windshield wiper and washer type 2) position, move the switch up and down to change the sensitivity of front wipers, and the rain sensor will adjust the wiping rate of front wipers.

Before You Drive

Caution

In freezing or very hot conditions, to prevent damage to the wipers, ensure the blades are not frozen or otherwise adhering to the glass, and clear the screen of obstructions such as snow. Do not operate wipers when the windshield is dry. It can scratch the glass, cause the blades to wear prematurely and obscure vision.

Rear window wiper and washer

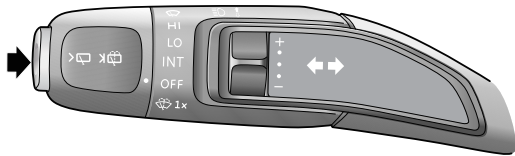

Short press the leftmost top of the wiper and washer lever switch, and the rear window wiper will operate.

Long press the leftmost top of the wiper and washer lever switch, the washer will spray water and the wipers will operate.

High beam, turn signal lever switch

Turn signals and direction indicators

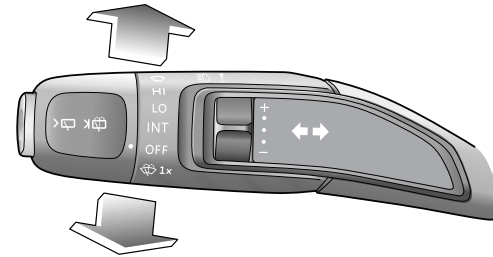

Right turn — push the lever switch upward.

Left turn — pull the lever switch downward.

The appropriate "direction indicators (green)" in the instrument cluster illuminate in time with the turn signals.

Before You Drive

Headlight high and low beams

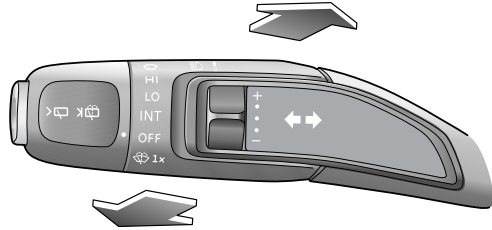

Push the lever switch away from the steering wheel, turn on the high beam, and at this time, the switch will automatically return to its original position; push the lever switch again away from the steering wheel, turn off the high beam, and at this time, the switch will automatically return to its original position.

Note: The "headlight high beam indicator (blue)" in the instrument cluster illuminates when the headlights are on high beam. To flash the headlights, slightly lift the lever switch intermittently towards the steering wheel.

Instrument cluster selection and cruise switch

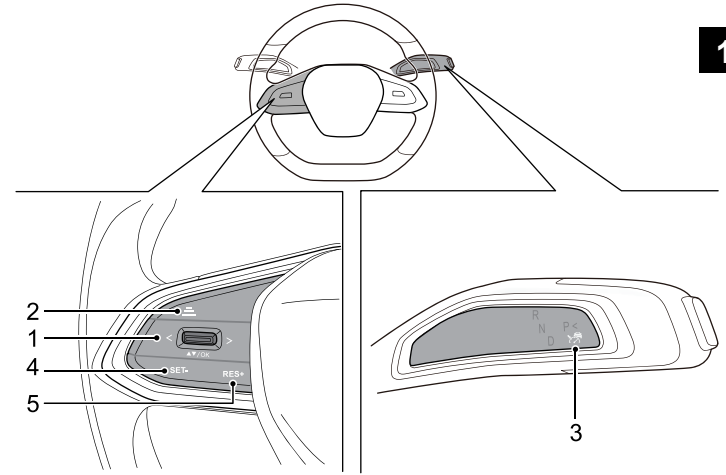

1



Position 1—  : Instrument cluster selection switch. Press upward, downward, leftward or rightward to page up, page down, page left or page right on the instrument cluster; press OK button to confirm your selection.

Position 2—  : Settings of following distance. Adjust the following distance controlled by cruise function, and press it once to switch the following distance from Level 1 to Level 3 cyclically.

Before You Drive

ACC (Adaptive Cruise Control)

Position 3—: Adaptive cruise control switch. If the conditions are met, move the shift lever down to the bottom and release it to activate the ACC (Adaptive Cruise Control) function. To manually deactivate the cruise control, pull up the shift lever or shift the gear, and depress the brake pedal. See "ACC (Adaptive Cruise Control)" in the Starting and Driving section for more descriptions.

ICA (Integrated Cruise Assist)

Position 3—: Integrated cruise assist switch. If the conditions are met, move the shift lever down to the bottom twice and release it to activate the ICA (Integrated Cruise Assist) function. To manually deactivate the cruise control, pull up the shift lever or shift the gear, and depress the brake pedal. See "ICA (Integrated Cruise Assist)" in the Starting and Driving section for more descriptions.



When the cruise control is activated:

Position 4—SET-: To decrease the cruise speed.

Position 5—RES+: To increase the cruise speed.

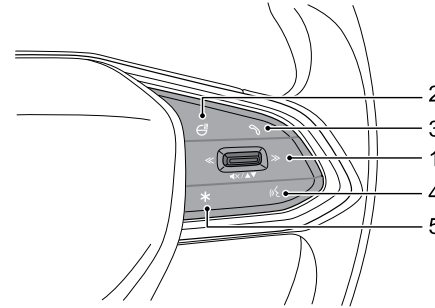
Voice control, Bluetooth telephone and custom settings switch



Position 1—: Volume control switch. Press upward to increase the volume and downward to decrease; long press to mute; short press , to switch to the previous band/MP3 track; long press to perform fast backward; short press  to switch to the next band; long press to perform fast forward.

Position 2—: Steering wheel heating switch. Press this switch to enable the steering wheel heating function, and the indicator illuminates. Press this switch again to disable the steering wheel heating function.

Position 3—: Bluetooth telephone switch. This switch is a phone call answer with Bluetooth switch when Bluetooth is connected. In the general calling state: in case of an incoming call, short press this button to answer; long press this button to

Before You Drive

hang up; during a call, short press this button to hang up. In the call waiting state: short press this button to hang up the call waiting; long press this button to answer the call waiting.

Position 4—: speech dialogue system switch. Press this switch to enable the speech recognition function; press again to disable the function.

Position 5—: custom settings switch. Press this switch to enable custom settings. Please use it in combination with the relevant functions supporting custom settings in the entertainment system with Internet of Vehicles feature. For example, enter the Vehicle Settings, then select Steering Wheel, and set the custom settings switch (intercom/snapshot function):

- Intercom: set this mode to make calls between fleet members in fleet mode. Press the button to start a call and press again to end it. Please enter the fleet interface to set the application scenario.
- Snapshot: the snapshot function needs to be able to access a camera device, such as DDP AI. Please enter the smart device interface to add related smart devices.

Horn

Regardless of whether the vehicle is powered on or not, press the button, and the horn can work.

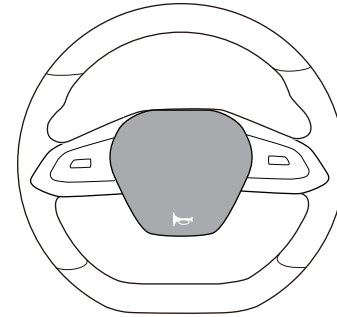

1

Before You Drive

Steering wheel adjustment

! Do not adjust the steering wheel position during driving. This is extremely dangerous.

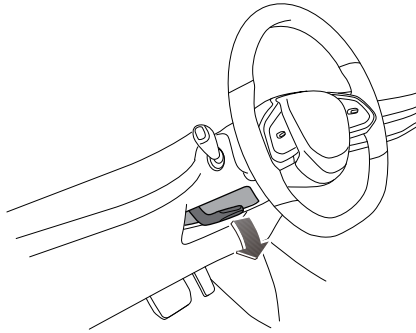

Adjust the steering wheel position to adapt to your driving posture through the following steps:

- 1 Fully release the steering wheel adjusting handle on the steering column downwards.
- 2 Grasp the steering wheel firmly with both hands, and move the steering wheel upward/downward and forward/backward to adjust it to a proper position.
- 3 Select a proper driving position, and pull the steering wheel adjusting handle fully up to lock the steering wheel into its new position.

Heating, ventilation and air conditioning (HVAC)

The air conditioning system cools the air and removes moisture and dust e.g. pollen.

The heating system utilizes high-pressure electronic heater, therefore, the interior air heating function is only available when the vehicle is under high pressure.

The ventilation system ensures the interior ventilation when the vehicle is moving.

The front/rear A/C air volume selection button is used to control the air volume.

HVAC is used to control the interior air cooling, heating and ventilation. Fresh air enters the vehicle through the air inlet grille under the windshield and flowing through the A/C filter. Always keep the air inlet grille clean and free of obstructions such as leaves, snow or ice.

Before You Drive

Front vents

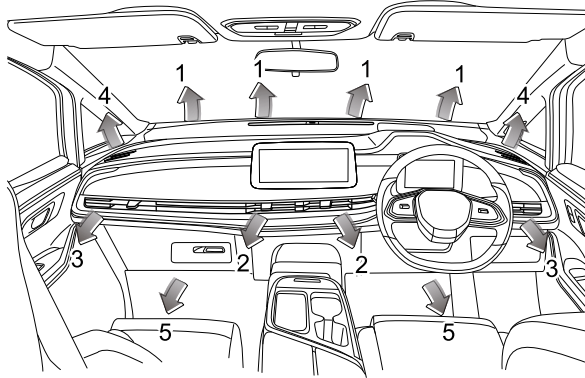

- 1 Windshield vents
- 2 Central vents
- 3 Side vents
- 4 Front door window vents
- 5 Front footwell vents

Central vents

For vehicles with manually adjusted vents, Move the lever (1) in the center of the grille up and down, right and left to change the direction of the air blowing.

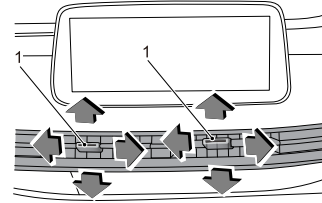

Side vents

For vehicles with manually adjusted vents, Move the lever in the center of the grille up and down, right and left to change the direction of the air blowing.

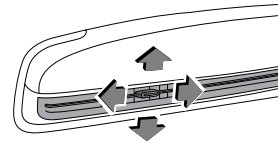

Note: For vehicles with electrically adjusted vents, please enter the setting interface on the center console screen for adjustment.

Before You Drive

Rear vents

The direction of air flow can be changed by revolving the grille or moving the plate (1) in the center of the grille. There are four vents on the roof, two on the right and left, respectively.

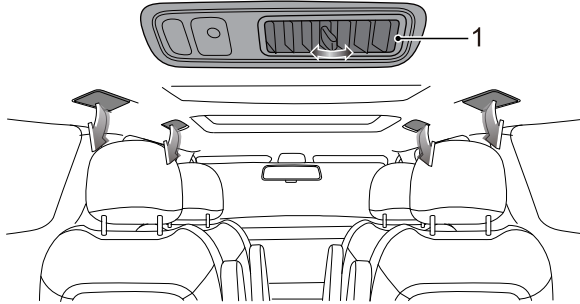

Front A/C control switch

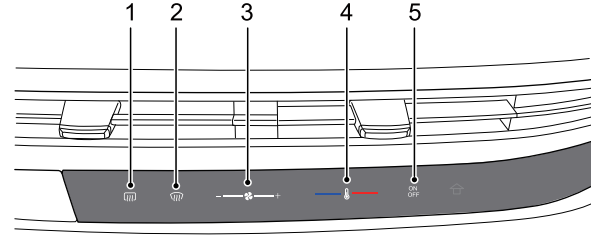

- 1 Rear defrost button
- 2 Front defrost button
- 3 Air volume adjusting slider
- 4 Temperature adjusting slider
- 5 Power button

Power button

Air conditioning on/off button.

If the indicator illuminates, it indicates that the air conditioner is on, and the air conditioning functions will be enabled according to the status before shutdown; if the indicator goes out, it indicates that the air conditioner is off, and the air blower, compressor and other air conditioning functions are disabled.

Temperature adjusting slider

Adjust the A/C setting temperature.

With the panel turned on, the set temperature decreases when you slide to the left or click on the left; the set temperature rises when you slide to the right or click on the right. Temperature adjusting range: LO (17°C), 18°C - 32°C and HI (33°C).

Air volume adjusting slider

To control the blower speed.

With the panel turned on, the set air volume decreases when you slide to the left or click on the left; the set air volume rises when you slide to the right or click on the right. There are 8 gears for air volume adjusting.

Front defrost button

Switch on the Front Defrost state.

When the Front Defrost button is operated, the corresponding indicator illuminates, A/C is turned on at the same time, and the air outlet mode is switched to defrost; turning on this function has a rapid defrost and defog effect on the front windshield and side glass. In the Front Defrost state, press the Front Defrost button or other mode buttons again to exit the defrost state.

Rear defrost button

Switch on the rear defrost state.

When the Rear Defrost button is operated, the corresponding indicator illuminates, and the rear defrost function is enabled; turning on this function has a rapid defrost and defog effect on the rear windshield.

For vehicles with heated exterior rearview mirrors, the function of heated exterior rearview mirror will be enabled when the Rear Defrost button is pressed, to help remove fog or frost from the surface of the rearview mirror.

Note: The rear defrost will stop after operating for 15 minutes, and its indicator goes off.

Before You Drive

A/C operation and display interfaces on center console screen

Front row A/C interface

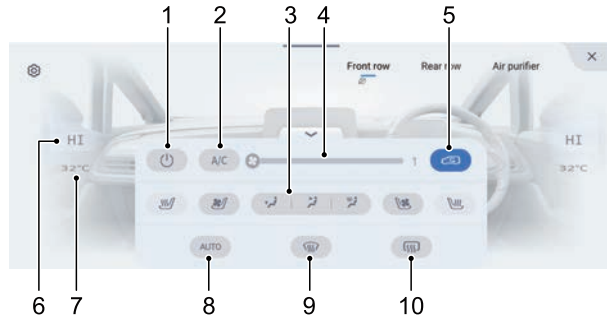

- 1 Power button
- 2 A/C button
- 3 Air outlet mode button
- 4 Air volume adjusting button
- 5 Internal/external circulation button
- 6 Temperature adjusting button
- 7 SYNC button
- 8 AUTO button
- 9 Front defrost button
- 10 Rear defrost button

Rear row A/C interface

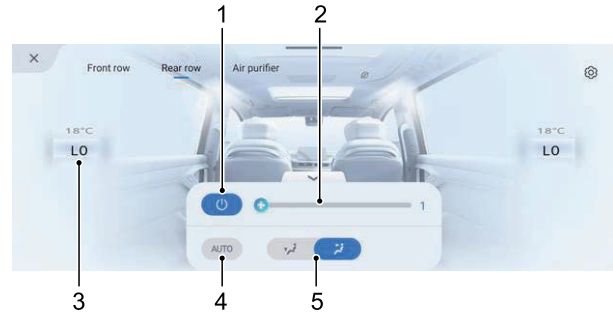

- 1 Power button
- 2 Air volume adjusting button
- 3 Temperature adjusting button
- 4 AUTO button
- 5 Air outlet mode button

Power button

Air conditioning on/off button.

If the indicator illuminates, it indicates that the air conditioner is on, and the air conditioning functions will be enabled according to the status before shutdown; if the indicator goes out, it indicates that the air conditioner is off, and the air blower, compressor and other air conditioning functions are disabled.

Temperature adjusting button

The front row A/C temperature adjusting button is used to adjust the required temperature of left/right A/C of front row A/C. The rear row A/C temperature adjusting button is used to adjust the required temperature of rear row A/C.

In any season, after the air conditioner is turned on, the A/C state will be adjusted as soon as possible, so that the temperature in the vehicle reaches the set temperature and remains stable.

There are 17 gears for temperature selection range; when the temperature is set to LO, the air conditioner is in the highest refrigerating power state; when the temperature is set to HI, the air conditioner is in the highest heating power state.

The set temperature of automatic air conditioner is between 22°C and 24°C, which is the recommended comfortable temperature.

If brief and continuous switching is performed between different set temperatures, the automatic air conditioner has no adequate time to be adjusted to the set temperature.

SYNC button

Synchronous temperature selection.

When the button illuminates, the set temperature at the front occupant side will be synchronized to the same as that at the driver side; when the temperature at the driver side is adjusted, the temperature at the front occupant side will change with it.

If the temperature at the front occupant side is adjusted individually, the temperature at the driver side will not change with it, the SYNC indicator goes out, and exits the SYNC state.

AUTO button

Turn on the automatic A/C function.

Press the AUTO button to enter the fully automatic state of the air conditioner, and the air volume, mode, circulation and other functions enter the automatic working state. In this case, the temperature knob can be operated as needed for comfort level to set the required temperature, based on which the A/C system will automatically adjust the vehicle environment, in order to reach the target temperature and maintain stability in the vehicle at the maximum speed.

In AUTO state, when the mode, air volume and A/C buttons are operated, the AUTO indicator goes out, the corresponding functions will exit the AUTO state, and other unoperated functions will remain in auto state.

A/C button

Switch on and off the compressor.

Operate the A/C button to illuminate the corresponding indicator; the air conditioner will turn on the compressor to cool the air in the vehicle, and has a certain dehumidification function.

The A/C indicator is always on in AUTO state (in automatic control state, which does not indicate that it is operating); if the

Before You Drive

A/C button is operated, A/C will exit the AUTO state and enter the state of manual control.

The compressor can only operate when the motor is operating.

Air outlet mode button

Adjust the air blowing mode.

Front row A/C air outlet mode is divided into face, footwell and window modes. Rear row A/C air outlet mode is divided into face and footwell modes. The corresponding indicator illuminates, indicating that there is air outlet in this direction, and you can freely combine air outlet modes according to needs. It's recommended to blow the face with cool wind in summer, blow the feet with hot wind in winter, and blow the window when there is fog on the front windshield, which is more convenient for improving the comfort level in the vehicle.

Air volume adjusting button

To control the blower speed.

There are 8 gears for air volume adjusting; air volume can be adjusted according to requirements for comfort level.

When the air conditioner is turned off, the A/C system can be turned on by setting air volume.

Internal/external circulation button

Internal/external circulation is switched through the button.

Operate the button to switch the A/C air inlet mode; external circulation indicates that the air enters the air conditioner from outside, and internal circulation indicates that the air circulates in the vehicle.

Internal circulation is recommended when refrigeration is required; external circulation is recommended when heating is required.

Front defrost button

Switch on the Front Defrost state.

When the Front Defrost button is operated, the corresponding indicator illuminates, A/C is turned on at the same time, and the air outlet mode is switched to defrost; turning on this function has a rapid defrost and defog effect on the front windshield and side glass. In the Front Defrost state, press the Front Defrost button or other mode buttons again to exit the defrost state.

Rear defrost button

Switch on the Rear Defrost state.

When the Rear Defrost button is operated, the corresponding indicator illuminates, and the rear defrost function is enabled; turning on this function has a rapid defrost and defog effect on the rear windshield.

For vehicles with heated exterior rearview mirrors, the function of heated exterior rearview mirror will be enabled when the Rear Defrost button is pressed, to help remove fog or frost from the surface of the rearview mirror.

Before You Drive

Note: *The rear defrost will stop after operating for 15 minutes, and its indicator goes off.*

Automatic defog button

After this function is turned on, the A/C system will automatically adjust its state according to interior humidity and temperature, to avoid fog on the glass inside the vehicle, and the effect will be better after A/C "AUTO" is turned on.

Bluetooth phone noise-reduction button

After this function is turned on, the A/C system will automatically decrease the air volume when Bluetooth phone is connected, so as to reduce the noise effect.

Maximum air volume limit button

After this function is turned on, the A/C system air volume will be limited in "AUTO" and "Front Defrost" modes, with the maximum not exceeding that in 7/6/5 gear.

Automatic fresh air switch time button

After this function is turned on, and internal/external circulation is in "AUTO" state, the A/C system will automatically switch the circulation mode every 10/20/30 minutes, to ensure that interior air is fresh.

Off-car ventilation button

After this function is turned on, if A/C (compressor) is in working state before engine shutdown, the A/C system will turn on the

blower again 30s after engine shutdown, and continue to blow air for 1 minute and dry the evaporator, to prevent the growth of mold.

A/C filter element remaining time and reset button

After reset, a dialog box "Please confirm whether filter element has been replaced" pops out; select "Yes", and the center console screen will send filter element reset signal to the air conditioner.

1

Before You Drive

Rear A/C control panel

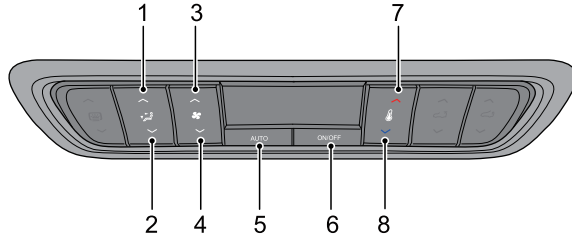

- 1 Air outlet mode button
- 2 Air outlet mode button
- 3 Blower speed increase button
- 4 Blower speed decrease button
- 5 AUTO button
- 6 Power button
- 7 Temperature increase button
- 8 Temperature decrease button

Air outlet mode button

Adjust the air blowing mode.

A/C air outlet mode is divided into face, face/footwell and footwell modes; adjust up/down to switch air outlet mode in order; it's recommended to blow the face with cool wind in summer and blow the feet with hot wind in winter, which is more convenient for improving the comfort level in the vehicle.

Air volume adjusting button

To control the blower speed.

There are 8 gears for air volume adjusting; air volume can be adjusted according to requirements for comfort level. Press the blower speed increase button (3), to increase the blower speed; press the blower speed decrease button (4), to decrease the blower speed.

When the air conditioner is turned off, the A/C system can be turned on by setting air volume.

AUTO button

Turn on the automatic air conditioner.

Press the AUTO button (5) to enter the fully automatic state of the air conditioner, and the air volume, mode, circulation and other functions enter the automatic working state. In this case, the temperature knob can be operated as needed for comfort level to set the required temperature, based on which the A/C system will automatically adjust the vehicle environment, in order to reach the target temperature and maintain stability in the vehicle at the maximum speed.

In AUTO state, when the mode and air volume buttons are operated, the AUTO indicator goes out, the corresponding functions will exit the AUTO state, and other unoperated functions will remain in auto state.

Power button

Air conditioning on/off button.

Press the power button (6), and indicator illuminates, indicating that the air conditioner is turned on, and the A/C function will be enabled according to the status before shutdown; press the power button (6) again, and indicator goes out, indicating that the air conditioner is turned off, and the air blower and other A/C functions are disabled.

Temperature adjusting button

Adjust the required temperature of rear row A/C.

In any season, after the air conditioner is turned on, the A/C state will be adjusted as soon as possible, so that the temperature of rear row A/C reaches the set temperature and remains stable.

There are 17 gears for temperature selection range; press the temperature increase button (7), to increase the set temperature; press the temperature decrease button (8), to decrease the set temperature. When the temperature is set to LO, the air conditioner is in the highest refrigerating power state (it's required to turn on the front A/C in the highest refrigerating mode); when the temperature is set to HI, the air conditioner is in the highest heating power state.

The set temperature of automatic air conditioner is between 22°C and 24°C, which is the recommended comfortable temperature.

If brief and continuous switching is performed between different set temperatures, the automatic air conditioner has no adequate time to be adjusted to the set temperature.

Air conditioning operating tips

- If the vehicle has been parked in direct sunlight, open the windows before operating.
- To clear misted windows on rainy days, operate the defrost button, which can decrease the humidity inside the vehicle timely and effectively. This is most effective during rainy weather and high humidity.
- Insufficient cooling may occur when driving in urban stop/start conditions.

Note: If the air conditioning will not be in use for more than one month, run the vehicle at idle speed and turn on the system for more than 10 minutes (once every month, including in winter). This aims to maintain the proper lubrication of the compressor and the seals, so as to extend the service life of the system.

Note: Condensation will be formed on the evaporator when the A/C is operating. So you may find a small pool of water under the vehicle after the vehicle is stopped.

Rearview mirrors

The exterior rearview mirror glasses are convex shaped to broaden the field of view: this makes objects appear smaller and further away than they really are.

Caution

Always check all rearview mirrors for cleanliness and positioning before driving; clean and adjust if necessary.

Exterior rearview mirrors

Power exterior rearview mirrors

Press the left (L) or right (R) switch (Figure 1) to select the exterior rearview mirror on the corresponding side. At the same time, the indicator near the L/R on the selected switch illuminates.

Press four arrows on the round switch (Figure 2), to adjust the angle of exterior rearview mirror.

Press the L or R switch (Figure 1) again, the corresponding indicator goes out, and the adjustment of mirror can be stopped to prevent accidentally modification of adjusted mirror angle.

Switches of exterior rearview mirror not equipped with power folding function

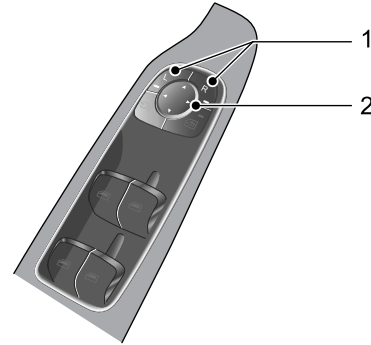

Switches of exterior rearview mirror equipped with power folding function

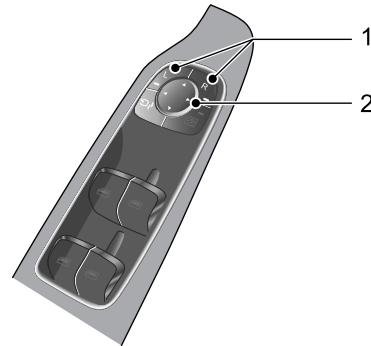

Folding of exterior rearview mirrors

Manual folding of exterior rearview mirrors

To protect the safety of pedestrians, the outside rear view mirrors will rotate to two sides from the normal installation position when suffering a strong impact. Reset the exterior rearview mirrors by applying little pressure onto the mirror frames.

Power folding exterior rearview mirrors

For vehicles equipped with power folding exterior rearview mirrors, it is allowed to fold/unfold exterior rearview mirrors manually/automatically.

- Manual/power folding/unfolding of exterior rearview mirrors
Press the folding switch on the driver side combination switch  (as indicated by the arrow), to automatically fold the exterior rearview mirrors. Press this switch again, to return the mirror frame to its original position.

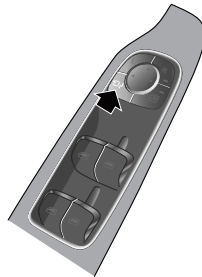

- Automatic/power folding/unfolding of exterior rearview mirrors

When the exterior rearview mirrors are folded and the vehicle power supply is turned off, the exterior rearview mirrors will be automatically unfolded after the vehicle is unlocked. When the vehicle is unlocked but the doors are not opened, after 30 s, the vehicle will be automatically locked again and exterior rearview mirrors will resume to folding state.

When the exterior rearview mirrors are unfolded, the vehicle power supply is turned off, and all doors and engine hood are closed, the exterior rearview mirrors will be automatically folded after the vehicle is locked.

The function setting of automatic/power folding exterior rearview mirrors can be conducted through the touch button on the center console screen.

Caution
Both the mirror power adjustment and the power folding of exterior rearview mirrors are operated by power switch, directly operating with hands may cause failures of relevant devices, and directly injecting the high-pressure water column will cause failures of electric device when washing the vehicle.

Before You Drive

Heated exterior rearview mirrors

For vehicles with heated exterior rearview mirrors, the exterior rearview mirrors are integrated with heating element, to remove the frost or fog on the mirror. The heating function of mirror is enabled together the rear window heating operation, that is to say, only after the power system is started, when the rear defrost button is enabled , the heating function of exterior rearview mirrors can function at the same time.

Memory function of exterior rearview mirrors

For vehicles with memory function of exterior rearview mirrors, the memory function of exterior rearview mirrors has 3 gears, bound with the seat memory function; enter the seat interface on the center console screen, to select the driver memory touch button, and adjust the exterior rearview mirrors according to the prompts. Short press the gear switch to select the position of exterior rearview mirrors at this gear.

Interior rearview mirrors

Adjust the interior rearview mirrors, to obtain possible optimum viewing angle. The anti-dazzle function of interior rearview mirrors can reduce the dazzling effect of vehicle headlights behind at night.

Manual anti-dazzle interior rearview mirrors

Move the adjusting handle at the bottom of interior rearview mirrors, to change the viewing angle of rearview mirrors, achieving the anti-dazzle function. Push the adjusting handle back to return the interior rearview mirrors to normal positions.

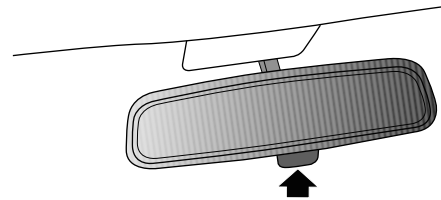

Note: *In some situations, using manual anti-dazzle function of interior rearview mirrors will enable the driver to have incorrect judgment of the position of vehicle behind.*

Before You Drive

Automatic anti-dazzle interior rearview mirrors

Type 1

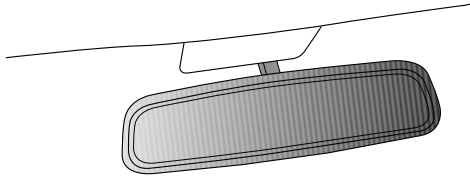

For vehicles with automatic anti-dazzle interior rearview mirrors, after the vehicle is powered on, the automatic anti-dazzle function is automatically enabled, when the driver may be dazzled by the vehicle headlights behind, the light sensor enables the anti-dazzle function. After the vehicle power-off, the automatic anti-dazzle function is turned off.

Automatic anti-dazzle function cannot be enabled normally in the following situations:

- When the light of vehicle behind cannot be directly shed on the light sensor.
- When selecting the reverse gear.

Note: *When the film is applied to the rear window glass, it may affect the usage of automatic anti-dazzle function.*

Type 2

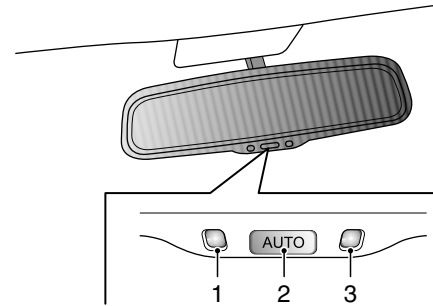

For vehicles with automatic anti-dazzle interior rearview mirrors, after the vehicle is powered on, press the automatic anti-dazzle function switch (2) at the bottom of rearview mirrors, the automatic anti-dazzle function is automatically enabled and the green working indicator (1) illuminates; when the driver may be dazzled by the vehicle headlights behind, the light sensor enables the anti-dazzle function. Press the automatic anti-dazzle function switch (2), the working indicator (1) goes out, and the automatic anti-dazzle function is turned off; press the switch again to re-enable this function.

- 1 Working indicator
- 2 Automatic anti-dazzle function switch
- 3 Light sensor

Automatic anti-dazzle function cannot be enabled normally in the following situations:

Before You Drive

- When the light of vehicle behind cannot be directly shed on the light sensor.
- When selecting the reverse gear.

Note: *When the film is applied to the rear window glass, it may affect the usage of automatic anti-dazzle function.*

Streaming media interior rearview mirrors

Streaming media rearview mirrors are to capture the image behind the vehicle in real-time manner through a camera (installed near the left license plate light of tailgate) mounted in the rear of vehicle, and show it on the streaming media interior rearview mirror display without loss and delay. That is to say, observe the real conditions behind the vehicle in the viewing angle of camera. Streaming media rearview mirror can greatly reduce the visual blind spot and improve the driving safety.

For vehicles with streaming media interior rearview mirrors, the streaming media function is enabled after vehicle power-on, to display the image behind the vehicle in a real-time manner.

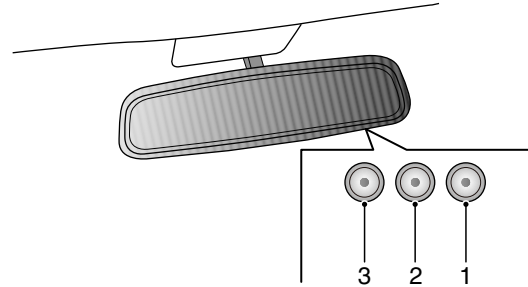

Long press the button (1) to switch the state of automatic anti-dazzle interior rearview mirror and streaming media. In streaming media state, short press the button (1) to enter the operation interface. Streaming media can adjust the visual field and color; visual field adjustment can be used to move images up and down, and adjust the scale of images.

Methods for moving images up and down:

- 1 Short press the button (1) to enter the visual field adjustment column, select the Move Up/Down option, and the color of font changes from blue to red, indicating that the adjustment function has been selected.
- 2 Short press the button (2) and button (3) to move up and down respectively.
- 3 After setting, short press the button (1), and the color of font changes from red to blue, indicating that the Up/Down adjustment function of visual field has been exited; short press the button (1) to exit the setting interface.

Methods for adjusting scale of visual field:

- 1 Short press the button (1) to enter the visual field adjustment column, select the Scale option, and the color of font changes from blue to red, indicating that the adjustment function has been selected.
- 2 Short press the button (2) and button (3) to scale up and down respectively.
- 3 After setting, short press the button (1), and the color of font changes from red to blue, indicating that the scale function of visual field has been exited; short press the button (1) to exit the setting interface.

Methods for adjusting color:



- 1 In streaming media state, first adjust it to the Color Adjustment option; short press the button (1) to select and enter the color adjustment function, then the color of font changes from blue to red, indicating the adjustment function has been selected.
- 2 Short press the button (2) and button (3) to make color adjustment of displayed image.
- 3 After setting, short press the button (1), and the color of font changes from red to blue, indicating that the color adjustment function has been exited; short press the button (1) to exit the setting interface.

Interior equipment

Roof vanity light

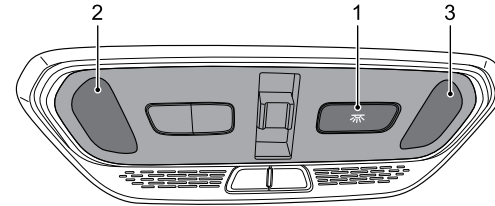
Front roof vanity light



Press the switch (1)  vanity lights on both sides and rear roof vanity light illuminate at the same time; press the switch (1) again , and the vanity lights on both sides and rear roof vanity light illuminate at the same time.

Touch light-emitting area of (2) with hands, and the left vanity light illuminates; touch light-emitting area of (2) again with hands, and the left vanity light goes out.

Touch light-emitting area of (3) with hands, and the right vanity light illuminates; touch light-emitting area of (3) again with hands, and the right vanity light goes out.



Note: (2) and (3) on the front roof vanity light are capacitive touch buttons; for daily touch usage, please touch the

Before You Drive

middle area. When touching, it's required to touch middle areas of (2) and (3) with a slight force with finger pulp, and it's recommended that the touch time should last for more than 1s. After touching, the finger is required to be more than one fist away from the touch pad, and touch the roof light at least 2 seconds apart.

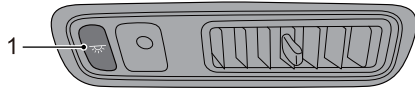
Rear roof vanity light



Press the switch (1) , and the rear roof vanity light illuminates; press the switch (1) again , and the rear roof vanity light goes out.

Note: *The rear roof vanity light will illuminate when any door is opened and will go out automatically about 30s after the door is closed. The roof vanity light will go out automatically about 15 minutes after any door is opened to avoid lack of battery power.*

Trunk light

The trunk light will automatically illuminate when the trunk lid is opened and will go out when the trunk lid is closed.

The trunk light will automatically go out when the trunk lid is kept open for more than 15 minutes.

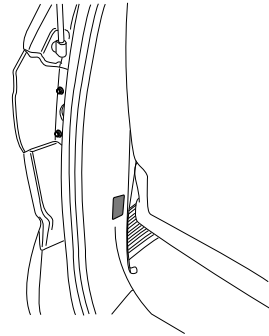

Stepwell light

The corresponding stepwell light illuminates when the sliding door is opened. The stepwell light will go out when the door is closed.

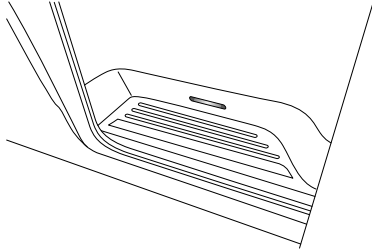

Note: *The stepwell light will automatically go out about 15 minutes after the slide door is opened avoid lack of battery power.*

Multi-color atmosphere light

Note: *It applies to vehicles configured with multi-color atmosphere light.*

The multi-color atmosphere lights may be located on the roof and front/rear door. Their position on your vehicle depends on the actual vehicle configuration you purchased.

The touch buttons on the central control screen can be used to control the on/off, color, brightness and illumination mode of multi-color atmosphere lights.

The multi-color atmosphere light has many detailed intelligent scenario functions, including: vehicle startup feedback, door unclosed reminder, welcome/farewell mode, incoming call/in-call reminder, voice interaction, music following, negative emotion feedback, key navigation information reminder and unlocked good mood.

You may set the lighting effects of multi-color atmosphere light for different scenes according to personal preference and lighting requirements, to configure a comfort function and safety alarm function in the vehicle.

Before You Drive

USB port

USB ports are located at the front windshield, below the dashboard, in the storage box under the auxiliary fascia console armrest, at the 2nd row single seat side, and on the 3rd row body-side panel. The position of USB ports on your vehicle shall be subject to the actual configuration of the vehicle you purchased.

Caution

Please do not use the USB port for a long time when the vehicle is powered on but has not started, which may cause the battery to lose power.

USB port at front windshield

USB port at front windshield can be used for charging.

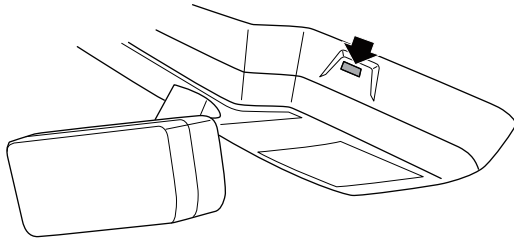

USB port located below dashboard

The left USB port below the dashboard can provide charging function; the right USB port below the dashboard can also provide charging function and play multi-media files.

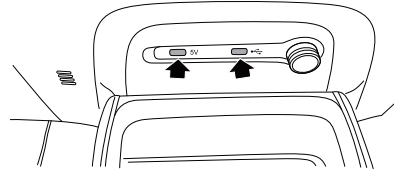

USB port in storage box under auxiliary fascia console armrest

The USB port in the storage box under auxiliary fascia console armrest can be used for charging and playing multi-media files.

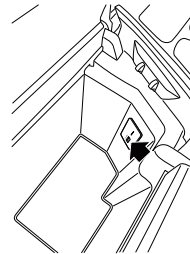

Before You Drive

USB port at 2nd row manually adjustable right single seat side

USB port at the 2nd row manually adjustable single seat side can be used for charging.

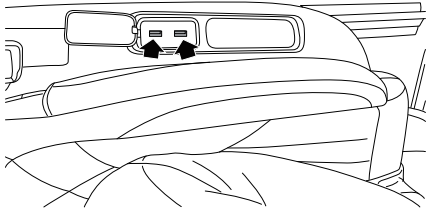

USB interface on the third-row side panel

USB port on 3rd row body-side panel can be used for charging.

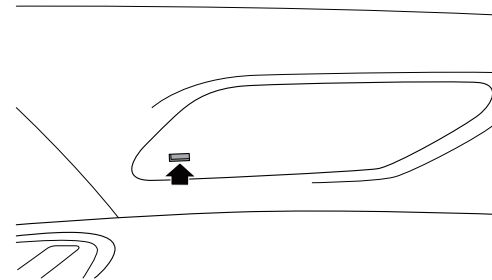

USB port and Type-C port at 2nd row electrically adjustable right single seat side

USB port and Type-C port at the 2nd row electrically adjustable right single seat side can be used for charging.

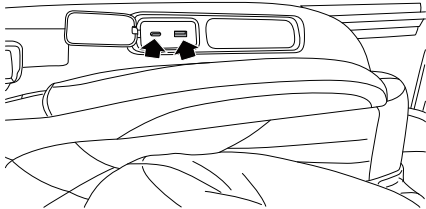

Before You Drive

12V power socket

Note: *It applies to vehicles configured 12V power socket.*

The power sockets are located at the auxiliary fascia console and the right side of the trunk, which are mainly used for providing power supply connection for external electric devices. The position of 12V power socket on your vehicle shall be subject to the actual configuration of the vehicle you purchased.

Caution

Please do not use the power socket for a long time when the vehicle is powered on but has not started, which may cause the battery to lose power.

Note: *The power socket can provide power supply for electric devices of which power is no more than 120W.*

12V power socket at auxiliary fascia console

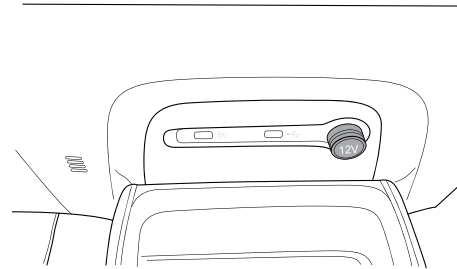

12V power socket at the right side of trunk

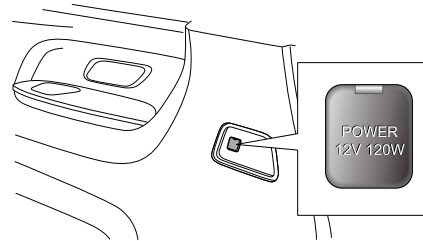

Wireless charging system for mobile phone

Note: *It applies to vehicles configured with wireless charging system for mobile phone.*

If your vehicle is configured with wireless charging system for mobile phone, then the system will enable mobile phone to be charged wirelessly through electromagnetic induction without wires connected.

Note: *The wireless charging system does not apply to all mobile phones, but only to the "Qi" certified mobile phones.*

Operations for mobile phone wireless charging

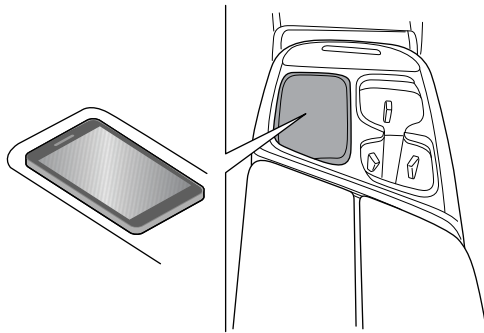

Place the mobile phone as shown in the figure above (with the screen forward), with the center of mobile phone aligned to the charging symbol.

When the mobile phone is being charged, the charging status icon will be displayed on the status bar of central control screen (There are also corresponding status icons to indicate completed charging and charging fault). When the engine stalls and the doors are closed, if the vehicle detects that the mobile phone is still being charged, it will remind the driver to never forget the mobile phone through pop-up window on the central control screen and prompt tone.

Note: *When the low-frequency antenna of PEPS system searches for key, the mobile phone wireless charging module may stop operating.*

Caution
Please do not use the wireless charging system for mobile phone for a long time when the vehicle is powered on but has not started, which may cause the battery to lose power.

Failure of mobile phone wireless charging

In case of any failure during charging, it may be caused by the followings:

- Low voltage of vehicle battery.
- In case of any metal foreign matter within charging area, please move away the mobile phone to check for foreign matter. If there is any, remove it and re-place the mobile phone in the charging area.
- High temperature.
- Internal failure of wireless charging system for mobile phone.

Before You Drive

- Failure of mobile phone.

Caution

- When driver is not in the vehicle, please do not place the mobile phone in the vehicle for charging, to avoid potential safety hazards.
- When charging, please do not place coin, key, chip card and other metal foreign matters in the charging area, which may cause the metal to be heated, resulting in charging failure and safety accident.
- Only one mobile phone can be charged each time.
- Do not spill water in the charging area, to prevent water from entering the wireless charger through the gap of rubber mat, resulting in charger failure.
- Mobile phone charging may stop when the temperature is high, and will continue after the temperature drops.

Vehicle inverter

Note: *It applies to the vehicles equipped with on-board inverter.*



Please pay attention to electric safety during usage. Prevent children from contacting this outlet. Danger! High voltage!

Do not insert finger or a conductive object into this outlet. Please keep liquid objects away from this outlet.

Do not use it in a humid, hot (more than 85°C) and unventilated environment.

The maximum rated power of inverter is 150W. Do not use any electric appliance with a power more than 150W.

On-board inverter is located behind the auxiliary fascia console. Open the panel, and you will see the 220V AC power outlet, which can provide an output power of 150W. During usage, please pay attention to the indicator showing the power supply operating state near the outlet, and operate according to the prompts provided by the indicator:

- 1 If the green light illuminates when an electrical appliance plug is inserted: The operation is normal.
- 2 If the indicator goes not when an electrical appliance plug is inserted: The battery voltage is too low, in this case, please

Before You Drive

1

remove the electrical appliance, and wait for the battery voltage to return to normal.

- 3 If the red light illuminates when an electrical appliance plug is inserted:
- The battery voltage is too high, in this case, please remove the electrical appliance, and wait for the battery voltage to return to normal.
 - The temperature of 220V power supply is too high, in this case, please remove the electrical appliance, and wait for a period of time before use it again.
 - The output of 220V power supply is overload, in this case, please remove the electrical appliance, and restart the vehicle to return to normal operation. Before reuse, please check if the power of electrical appliance meets requirements.
 - In case of external short-circuit, please remove the electrical appliance, and restart the vehicle to return to normal operation. Before reuse, please check if the electrical appliance are in good conditions.

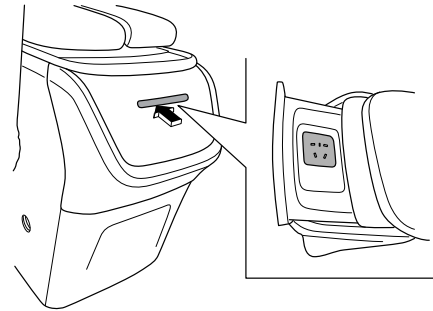

Caution

Please do not use the on-board inverter for a long time when the vehicle is powered on but has not started, which may cause the battery to lose power.

Before You Drive

Glove box

! Do not stow sharp, heavy or dangerous objects in the glove box at the passenger side.

Driving with the glove box open may cause injury in the event of an accident or sudden stop. Keep the glove box closed when driving.

Lift the flap handle to open the box. Close it with a firm push.

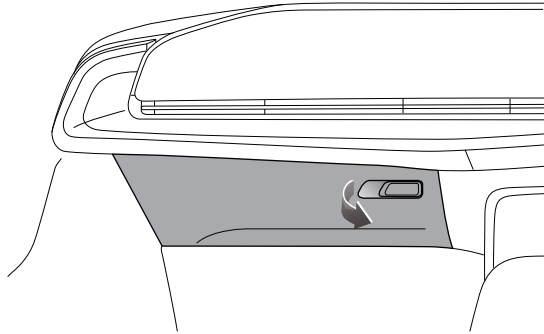

Storage box

Front compartment storage box

It is below the front compartment hood. Pull up twice the unlock handle of front compartment hood below the instrument desk on the driver side to unlock the front compartment, and lift the front compartment hood. Pull up the storage box buckle to open the front compartment storage box.

Note: Please close the front compartment hood after closing the front compartment storage box.

Caution

The storage weight shall not be more than 25kg.

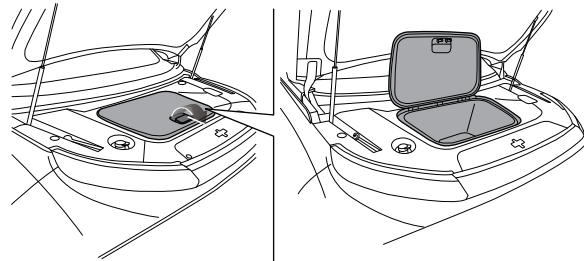

Before You Drive

Storage box on the driver side

It is located below the instrument desk on the driver side, and can be opened by pulling down the storage box buckle.

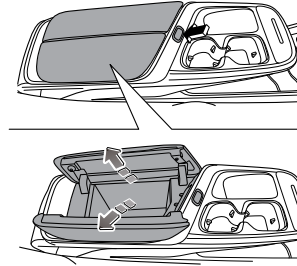
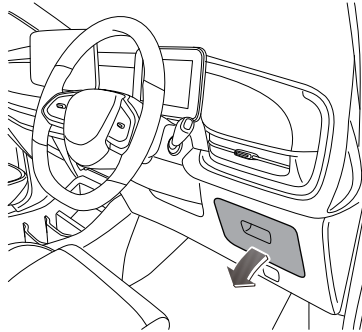

Storage box below the armrest of auxiliary fascia console

When the unlock button is pressed, the left and right armrest panels will eject to both sides to open the storage box. The armrest storage box of central control console can be closed by putting down the armrest.

Storage box at the rear bottom of auxiliary fascia console

It is a drawer-type storage box which can be opened by pulling back the storage box buckle.

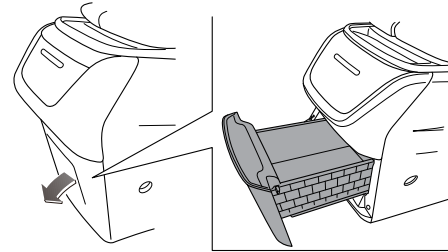

Before You Drive

Sun visor and vanity mirror

Both sun visors can be swung up and down to provide a shield through the windshield. Besides, sun visors can be rotated towards side windows.

Turn a sun visor downwards and open the vanity mirror cover. Then you can use the vanity mirror.

Driver's vanity mirror shall be used only when the vehicle stops.

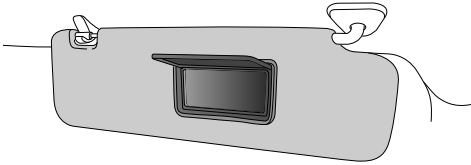

Fire extinguisher

Note: *It applies to the vehicles equipped with fire extinguisher.*

! Once activated, the fire extinguisher should be replaced even if there are not much spraying.

The fire extinguisher is placed below the front passenger seat.

How to use portable fire extinguisher

- 1 Pull the safety pin out.

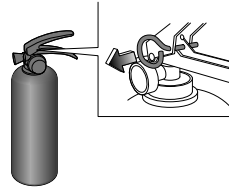

- 2 Aim at the base of the fire and squeeze the lever simultaneously to spray powder to put out the fire.

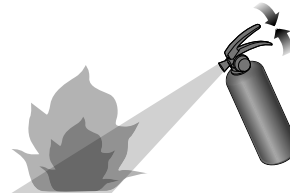

Before You Drive

When used outdoors, you should discharge the extinguisher in the wind direction. Intermittent discharging is also acceptable. To extinguish the flammable liquids, do not aim at the surface of liquid directly so as to prevent splashing of flammable liquids due to impact force from intensifying the fire condition, making the firefighting work even more difficult. To extinguish the ordinary solid materials, aim at the most intensely burning position and sweep the hose up and down, left and right. When conditions permit, you can discharge the extinguisher as you walk around the burning objects, so that the dry powder fire extinguishing agent can be sprayed evenly on the surface of burning object to put out the fire thoroughly. To extinguish the energized equipment (not applicable to the high voltage energized equipment), cut off the power first. The user of fire extinguisher shall pay more attention to avoid contacting the energized equipment so as to protect themselves from electric shock. Extinguish the fire thoroughly to avoid it flaring up again.

Inspection and maintenance for fire extinguisher

The user should inspect the fire extinguisher upon his/her receiving the vehicle and inspect at an interval of a quarter after then. In poor environment, the fire extinguisher should be checked more frequently. The contents to be inspected are as follows:

- 1 The pointer of pressure indicator of fire extinguisher should point to the green zone;
- 2 The safety pin and seal should be intact;

- 3 The barrel should be free of corrosion or deformation and all the parts free of deformation and damage.

Note: Non-professional personnel shall not remove the fire extinguisher without any permission so as to avoid accidents.

Caution

- Each fire extinguisher shall be inspected annually as of the manufacture date of the vehicle; fire extinguishing agents shall be replaced every 2 years and the fire extinguisher every 10 years.
- The annual inspection or after-use repair must be performed by an enterprise approved by Fire Department and having relevant qualifications to test, repair and annually inspect fire equipment.
- If the vehicle is sold, its owner is obliged to notify the purchaser of the cautions listed.

1

Before You Drive

Vehicle tools

The vehicle tools are placed in the front compartment storage box.

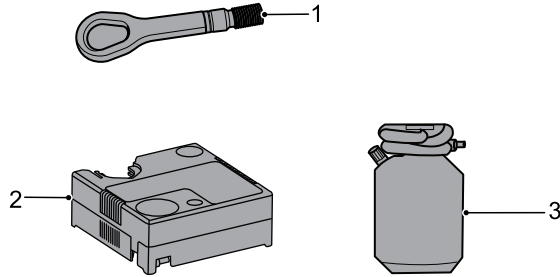

- 1 Towing hitch
- 2 Tire inflator pump (It applies to vehicles configured with tire repair kits.)
- 3 Tire repair glue pot (It applies to vehicles configured with tire repair kits.)

Entertainment system

The contents of this Handbook are simple instructions for the operation of the product. Please read carefully and fully understand the operating instructions accompanied with the entertainment system mainframe before you use this product.

! Please do not install or repair your product without authorization.

If the product is installed or repaired by a person who does not receive the training on electronic equipment and auto parts, a dangerous situation may be posed.

According to the relevant national regulations, watching videos and related operations are prohibited when driving, for the personal safety of yourself and others. Please do not watch the screen and perform related operations when driving a vehicle.

Please pay attention to all precautions mentioned in this section of the Handbook and strictly follow the operating instructions.

Never expose the product to any liquid, otherwise short circuit or damage may be caused.

The rear view camera function of the system just serves as a driving assist. Please pay attention to the actual situation.

Before You Drive

Caution

- The product shall be kept away from moisture. If the product is started for the first time or reconnected after the disconnection of vehicle power supply, the date shown on each interface of the mainframe needs to be adjusted manually. Be sure to drive safely. Make sure to follow the rules of safe driving and existing traffic regulations.
- Do not operate the product (and the rear view camera function) if it may distract you from safe driving.
- If you have to operate by watching the screen, park the vehicle in a safe place and apply the parking brake.
- Do not set the volume of the product too high, or you will not be able to hear the traffic and emergency signals outside.
- For the sake of safety, some features, such as video playback, will be disabled when driving.
- The system can detect the running speed of the vehicle. When the speed exceeds a certain value, the system will prevent you from watching video while driving. If you want to watch the video, park the vehicle in a safe place and apply the parking brake.
- In order to protect the battery from running out, please make sure to start the vehicle when the system is used.
- The pictures in this Handbook are schematic diagrams which may be slightly different from the real car in details and are for reference only. As for the specific colors and functions of the interface, please refer to the real vehicle.

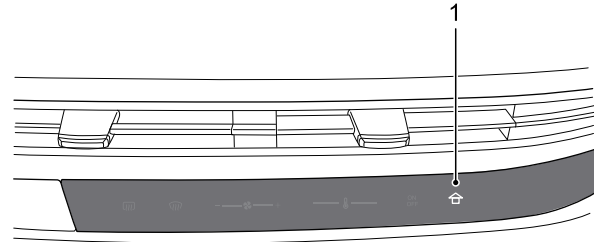

1 HOME Button

Short press the HOME button (1) to return to the HOME page from other interfaces; if the current page is the HOME page, this action is invalid.

Long press the HOME button (1) for about 10 seconds to restart the entertainment system.

Before You Drive

For the user guide and help of the entertainment system, please follow the following steps to access the related application of the vehicle entertainment system.

Note: *As the entertainment system software will continue to be updated and iterated, the pictures in this manual are only schematic diagrams, which may be slightly different from this vehicle. They are for reference only, and the actual vehicle status shall prevail.*

Center console screen

- 1 On the HOME screen, click the "Application Center" icon ① to expand all application interfaces.
- 2 On the application interface, click the "User Manual" icon ② in the application center to view the instructions of the entertainment system.

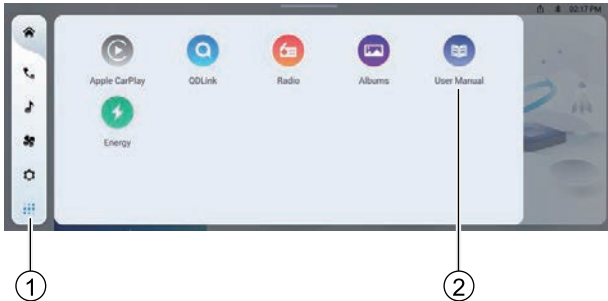

Starting and Driving

134 Before Starting and Driving

134 Start/stop vehicle

135 PEPS system

137 Driving

138 Gear shift

141 Charging requirement

154 Low speed alarm module

155 Electric power steering system

156 Braking system

165 Parking assist system

171 Driver assistance system

202 Driver status monitor system

204 Tires

206 Loading

207 Trailer towing

Starting and Driving

Before Starting and Driving

- Ensure that the daily/weekly maintenance checks have been done as detailed in the section "Maintenance and Service - Owner's Check".
 - Check that the seat is in the right position.
 - Check that the adjustment of all the rearview mirrors is in place.
 - Check that all lights, signal systems and warning indicators operate normally.
 - Check that all passengers have correctly fastened seat belts.
- With the vehicle is powered on, check that all warning lights and gauges are operating normally (Please see "Warning lights and indicators" in the Before You Drive section).

Caution

Be sure you have read the "Before You Drive" section of this Handbook and a good understanding of your vehicle and its equipment before reading this section.

Start/stop vehicle

Power on vehicle

Unlock the vehicle with key. When the driver door is opened, the vehicle can be powered on automatically.

Start vehicle

The vehicle not started can be started when meeting the following conditions.

- Enter the vehicle with a valid key.
- Step on the brake pedal, and switch the gear to D gear or R gear to start the vehicle ("READY indicator" on the instrument cluster illuminates).

Power off vehicle

With the vehicle kept stationary, switch the gear to P gear, leave the vehicle, close the driver door, and turn off the vehicle power supply.

Caution

- In this scenario, if you enable the "No Power-off for Temporary Parking" mode on the central control screen, then the vehicle will be kept powered on.
- In this scenario, you can also turn off the vehicle power supply through the "Vehicle Power Off" mode in the "Settings" page on the central control screen.

Automatic power off

With the vehicle kept stationary, switch the gear to P gear without stepping on the brake pedal, and the vehicle will automatically be powered off 10 minutes later; if the “No Power-off for Temporary Parking” mode is enabled, the vehicle will automatically be powered off 60 minutes later.

Emergency power off

When the vehicle is kept stationary, if it needs to be powered off in emergency in case of sudden conditions, please long press the hazard warning light switch for 5s, or press it for 5 consecutive times in 3s to turn off the vehicle power supply.

When the vehicle is running, if it needs to power off the vehicle in emergency in case of sudden conditions, please step on the brake pedal while pressing the hazard warning light switch for 5 consecutive times in 3s to turn off the vehicle power supply.

PEPS system

Keyless unlocking

When all doors are locked, enter the sensing area with a remote key and press the microswitch or tailgate switch on the door handle, the central lock will unlock automatically. After unlocking, turn signal lamps will flash twice. If you do not conduct any of the following operations within 30s after that, the central lock will automatically lock again:

- Open any door
- Shift the power supply position to a non-OFF position
- Operate the central lock to unlock/lock

Note: *It is feasible to unlock doors with the central unlocking button on the remote key. Press the central unlocking button once, and the central lock will unlock automatically.*

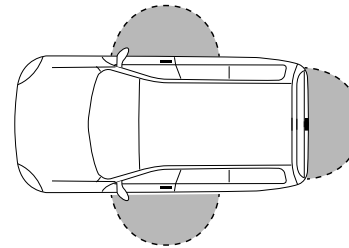

Starting and Driving

Keyless locking

When the driver's door or front passenger door is in unlocked state, enter the sensing area with a remote key, and then press the micro switch on the door handle. The direction indicators will flash once, meanwhile the alarm horn will ring once for a short time (as appropriate). Then all doors will be locked, meanwhile the vehicle enters the fortification state. In any of the following cases, the doors will not be locked after the micro switch is pressed:

- The power supply switch is placed in non-OFF position
- The remote key is left in the vehicle
- The remote key is not in the sensing range
- The remote key battery is low
- The driver's door is open

Note: It is feasible to lock doors with the central locking button on the remote key. Press the central locking button once, and the central lock will lock automatically.

Keyless start

With the key inserted, the front compartment hood closed, the shift lever in P or N gear, step on the brake pedal to start the vehicle.

Backup starting

When the remote control battery is low, the keyless entry function will fail, but you still can start the vehicle. Open a door with the mechanical key and enter the vehicle. At this time, the system may be in IMMO state and the alarm may be triggered, which is a normal situation.

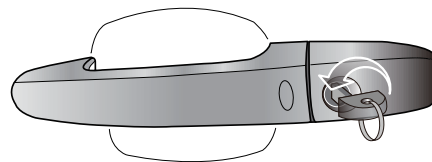

With the shift level in P or N gear, place the remote key in the cup holder with a symbol (🔑) on the auxiliary fascia console, and step on the brake pedal to start the vehicle. In this case, the system will release IMMO.

Type 1

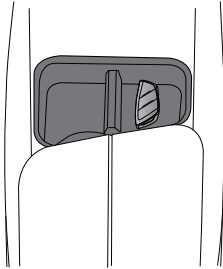

Type 2

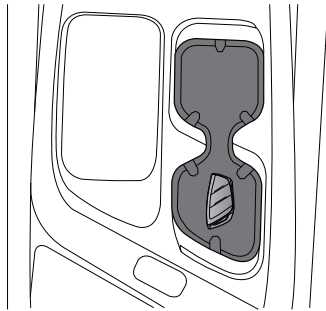

Driving

! When driving, never place any portable container with fuel on the vehicle. Otherwise it may leak and a fire may result.

When driving on a risky road covered with water, snow, ice, mud, sand, etc., please:

- Slow down, drive with care and reserve longer brake distance.
- Avoid any sudden operation during braking, steering or acceleration.
- Apply sand or other anti-skid material under the drive wheels to provide the traction needed when the vehicle gets stuck in ice, snow or mud.

Skid

If your vehicle skids on a wet road, you cannot control the vehicle due to the decrease of friction force between the road and tires. Different road surfaces, tire inflating pressures and vehicle speeds may lead to skid. Skid is very dangerous.

The optimum method to stop skid is lowering driving speed and keep cautious when you feel the road is wet enough.

Starting and Driving

Wading driving

In order to avoid damage to your vehicle, when passing a road with gathered water, please:

- Confirm the water depth before the wading driving. The maximum wading depth of the vehicle is 30cm.
- Keep the driving speed lower than the walking speed.
- The wave caused by front vehicle and head-on vehicles may cause the wading depth to exceed the maximum allowed depth.

 **Water and mud can affect the braking system and lengthen braking distance, leading to an accident!**

- Slightly depress the brake pedal to keep brake parts dry and recover performance.
- Do not conduct an emergency brake when passing a slippery road.

Note: The motor, high voltage battery pack, transmission and electronic system of the vehicle may be severely damaged after the vehicle drives on a road with gathered water.

Gear shift

Gear position

P (Park Gear)

 **Parking into the P (park) gear during vehicle running will cause transmission damage. Do not use P (park) gear in place of the electronic parking brake. Make sure the shift lever is in P (park) gear and the electronic parking brake is fully applied.**

The vehicle must be stopped completely before shifting into P (park) gear.

R (Reverse gear)

 **The vehicle must be completely stopped before shifting into/out of R (reverse) gear; shifting into R gear during vehicle running will cause reducer damage.**

R gear is used for reversing.

When switching from P to R gear, or switching from N to R gear, or switching from D to R gear, step on the brake pedal.

Starting and Driving

N (Neutral)

! When you stop the vehicle temporarily in N gear, please apply the parking brake or depress the brake pedal, otherwise there might be the risk of rolling or accident. While driving, please do not shift into N gear.

N gear is a non-power gear, in which the transmission system does not transmit power. Shift into the N gear when the vehicle is in a car wash device.

D (Drive)

D gear is a common forward gear, during normal driving, it is recommended to use D gear. The transmission can make adaptive adjustment of speed ratio, to achieve the optimal economy.

Shifting operation

! Situation of the mass surrounding the vehicle especially children must be checked before shifting to D (forward) or R (reverse) gear. Make sure the shift lever is in P (park) position before leaving the driver seat; then apply the parking brake and turn off the vehicle power.

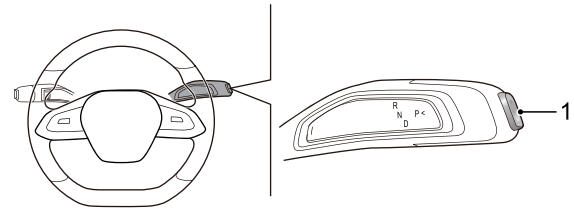

1 P gear button

Starting and Driving

Shift into P gear



When the vehicle is stationary, press the P gear button (1), and the vehicle engages the P gear.

Shift into R, N or D gear

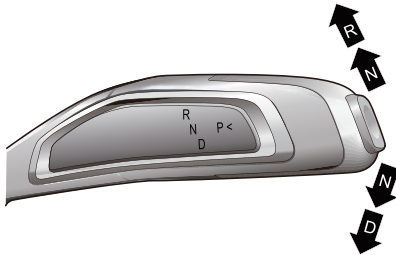

Depress the brake pedal and briefly push or pull the shift lever towards the required direction (two positions each for up and

down). After releasing the shift lever, the shift lever will return to the middle position.

Auto Park (automatically return to P gear function)

When the vehicle is started, and the driver leaves the vehicle in D, N or R gear (the movement to open the driver's door to leave the seat), the vehicle will automatically return to P gear to prevent any crack or the risk of vehicle collision and slipping.

Note: *When the the vehicle is powered off, the vehicle will automatically switch to P gear, no matter what gear it is currently in. The vehicle should remain started and N gear should be engaged while the vehicle is in a car wash device to prevent automatic shifting to P gear after the vehicle is powered off.*

Charging requirement

 Slow charging is generally recommended for the vehicle; frequent use of fast charging should be avoided.

Check will be conducted to confirm whether the inlets and jacks are in good condition or not before charging.

It is recommended that the charging connector should be connected to the charging inlet in the body before operating the charging equipment.

In the process of charging operation, surrounding personnel cannot contact operators, vehicle and power supply equipment.

After charging, turn the power of the charging equipment off first, then disconnect the charging connector from the charging inlet in the vehicle body, and close the charging inlet cover as well as the charging port panel on the body.

When the charging pile breaks down, immediately notify the relevant professional, and the operator cannot handle it without authorization.

Charging can be conducted in rainy days, but rainproof measures will be adopted for charging connector and charging port in the process of removing and inserting charging connector.

 Charging operation need be stopped in extreme weather such as storm.

In the charging process, key cannot be inserted for starting. It is strictly forbidden to charge when there is a person in the vehicle.

Do not conduct fast charging and slow charging simultaneously.

Starting and Driving

Requirements for charging equipment

Requirements for battery charger

- Insulation resistance $\geq 10M\Omega$.
- Low voltage auxiliary power supply of charger shall not be greater than 10mA.
- As low-voltage platform of the vehicle is 12V, charging pile whose low voltage output is 12V will be used for charging to avoid damaging low voltage equipment of vehicle.
- The high voltage output of the charger is greater than 460V.

Special requirements

- The charging equipment must meet Standard IEC 62196.

Safety instructions for charging with residential electricity

Basic principles

- Charging pile is not provided for charging with residential electricity. For charging piles purchased by customers themselves, it is recommended being installed by professionals.
- When charging from a household outlet, avoid using other electrical equipment on the same power line.
- Power supply circuit at the customer side shall be evaluated by qualified professionals.

Requirements for electricity leakage protection device

- Electricity leakage protection device shall be used on the power supply circuit at the customer side, and installed at the frontmost end of the power supply circuit.
- High-sensitivity high-speed electricity leakage protection devices with a sensitive current of 30mA or smaller leakage current value are recommended.

Requirements for over-current protector (air switch)

- Over-current protector must be installed on the power supply circuit, behind and close to the electricity leakage protection device.

Starting and Driving

Requirements for circuit cable

- Power supply circuit at the customer side must be a special circuit, and circuit wiring shall conform to the related requirements for building and electricity.
- For old buildings, it is recommended arranging new special circuit.
- The diameter of power supply circuit cable at the customer side shall be no less than 4 sq.mm and the total length of cable shall be no more than 50 m.
- Circuit wiring shall avoid the humid or water logged area and be free of flammable substances around.

Requirements for household socket outlet

- Socket must be arranged in positions convenient for vehicle parking and charging operation.
- Standard 220V/13A (Users in British standard area) or standard 220V/16A (Users in German standard area) AC power sockets are recommended.
- The wiring of the socket should be correct (live wire, neutral wire and earth wire), and the earth wire should be reliably earthed.
- Transfers using adapters, reels, power strips, etc. are prohibited.
- The socket must be protected from rain, sun and foreign objects, and there is no heat source around.
- The socket shall conform to the requirements of IEC 60884, and be reliable in quality.

Miscellaneous

- After the battery is fully charged, disconnect the charging cable; if it is needed to actively stop the charging, first disconnect the charging connector from the vehicle, and remove the plug at the power supply side.
- During charging operation in rainy days, rain shall be avoided from entering the charging connector and inlet.
- Check the connector/inlet for deformation, blackening or ablation before each charge, and replace it immediately if any abnormal condition is found. Even if there is no abnormal condition, if it is used for over 3 years, replace it with a new one.
- If there is peculiar smell, smoking, overheating or other abnormal conditions during charging, immediately turn off the charging circuit, stop the charging operation and check the connector and inlet.
- If the over-temperature fault lamp for charging cable illuminates, check the connector/inlet for deformation, blackening or ablation, and replace it immediately if any abnormal condition is found.

Starting and Driving

Requirements for charging environment

- Spark may be generated in some modules of charging equipment. To avoid accident, do not conduct charging operation in gas station and places where there are inflammable gases or liquid.
- Charging operation time will be affected by external temperature. Charging time will be extended at low temperatures.

Influence of charging operation on special personnel

When conducting fast charging, the operation area may have magnetic field interference. It is recommended that users who carry implantable heart pacemaker and implantable angiocardy defibrillator keep away from vehicles under charging.

Magnetic field interference may affect normal effect of electronic medical equipment such as implantable heart pacemaker and implantable angiocardy defibrillator. Users who carry implantable heart pacemaker and implantable angiocardy defibrillator may be injured or die.

If you carry implantable heart pacemaker and implantable angiocardy defibrillator, please guarantee when vehicle is under charging operation:

- Don't stay in the vehicle.
- Don't enter into the vehicle for taking objects in the passenger compartment.
- Don't open the tail gate or enter into the vehicle for taking objects at the tail gate.

Note: *When the vehicle does not conduct charging operation, special personnel can ride and drive vehicles.*

Starting and Driving

Charging mode

Charging pile DC charging (fast charging)

Use the public DC charging piles to charge your vehicle.

Please refer to the following table and attached drawings. The **K** label on the vehicle charging port indicates that the vehicle supports the fast charging shown in the following table.

Household single-phase AC charging (slow charging)

Connect the vehicle to a household standard household socket to charge the vehicle, if the socket is not well grounded, the charging device will have a failure prompt for unable to charge. You need to contact a professional electrician to repair the ground wire or connect it to a well-grounded socket for charging. Check the power socket in the process of charging. If it is hot, do not continue to use it. Contact a qualified electrician for servicing the power socket.

Always use the standard household socket which meets the provisions in IEC 60884 for charging.

If a 'Electric Leakage' prompt is displayed, contact a professional electrician to check the insulation status of the hot wire or the neutral wire.

Special power sockets should be selected for battery charging, as they can prevent line damage and protection trip caused by high-power charging from affecting the normal use of other equipment. Over time, the power socket may wear out due to

normal use and may even be damaged, making it no longer suitable for charging an electric vehicle.

When used outdoors, plug it into a power socket that is protected from rain.

Charging pile AC charging (slow charging)

Use the public AC charging piles to charge your vehicle.

Please refer to the following table and attached drawings. The **C** label on the vehicle charging port indicates that the vehicle supports the slow charging shown in the following table.

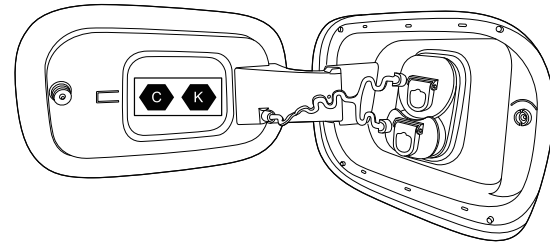

Configuration	Type of accessory	Voltage range	Identifier
TYPE 2	Vehicle inlet	≤480V RMS	C
FF	Vehicle inlet	50V ~ 500V	K

Starting and Driving

Fast charging

Note: *Fast charging should be conducted by the personnel in the fast charging station according to the operation instructions for charging pile.*

To perform a fast charging for the vehicle, turn the power switch off, remove the key, wait for 3 ~ 5 minutes, and then follow the instructions below:

- 1 Select a standard DC charging connector that matches your vehicle.
- 2 The charging port is at the left rear side of the vehicle. Gently press the right side of the charging port panel by hand to open the panel.

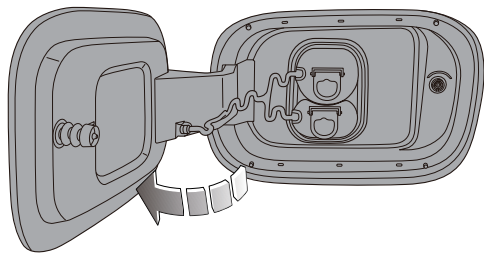

- 3 Open the cover on the charging inlet.

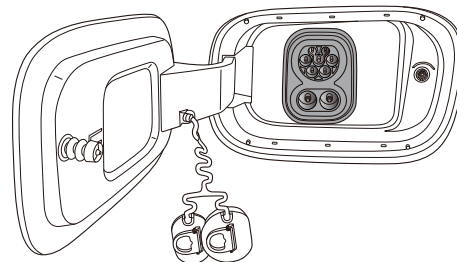

- 4 Remove the DC charging connector from the charging pile.
- 5 Connect the charging connector with the charging socket, and lock the connection of the charging connector and charging socket using the locking mechanism on the charging connector handle.
- 6 Connect the charging connector to the charging equipment, and turn the power of the charging equipment on according to the instructions on the charging pile.

Note: *Before charging, check whether there is any abnormality in the charging equipment. In the charging process, the "charging status indicator (yellow)" on the instrument cluster illuminates. If the equipment can not be charged after 3 consecutive attempts, it is recommended to replace other equipment for attempts. If the equipment can be charged after replacement, the previous charging equipment may be damaged.*

Starting and Driving

Note: Please check whether the PP and CP pins of the charging connector are rusted. If so, please clean them before charging to prevent charging failure.

- After the charging connector is properly connected, the "charging connection indicator (red)" on the instrument cluster will come on.

Note: Please make sure that the charging connector is fully inserted into the charging stand to avoid that the electronic lock cannot be locked, resulting in charging failure, as shown below.

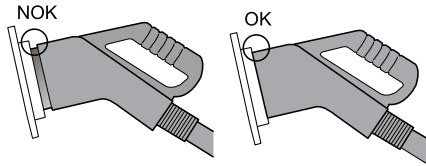

- In the charging process, the "charging status indicator (yellow)" on the instrument cluster illuminates.
- Upon completion of charging, the "charging status indicator (yellow)" goes out. Please turn the power of the charging equipment off before removing the charging connector.
- Close the cover on the charging inlet.

- Close the charging port panel.

Caution

Select a standard DC charging pile or charging equipment that matches your vehicle. Once the battery is fully charged, the battery management system will have an automatic calibration function. If the vehicle has been shallowly charged (less than 99%) every two or three times, you need to fully charge (100%) the vehicle once.

2

Starting and Driving

Slow charging

There are three ways to slow charge. The charging method on your vehicle depends on the actual configuration of your vehicle.

- 1 Mode 2 charging is shown in the figure below. One end of the charging in this mode is connected to the household socket and the other end is connected to the vehicle. (This connector is optional for users)

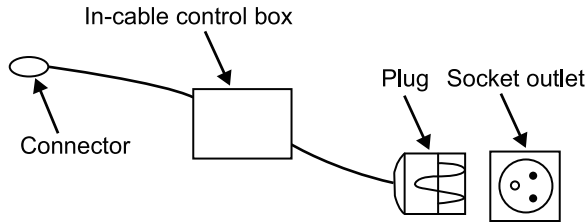

The LED words on the In-cable control box are as follows:

Charging status	Status description			
	Power (Green)	Charging (Red)	Fault (Red)	Complete (Green)
Initial state	On	Flash	Flash	Flash
To be connected	On	On	Off	Off
Normal charging	On	Off	Off	On
Charging completed	On	Off	Off	On

Power-on self-test failed	On	Off	Flash	Off
Abnormal communication	On	On	Flash	Off
Over/under voltage	On	Off	On	Off
Ungrounded	On	Off	On	Flash
Over current	On	Flash	On	Off
Current leakage	On	Off	Flash	Flash
Over temperature	On	On	On	On

- 2 Mode 3 charging is shown in the figure below. One end of the charging in this mode is connected to the charging piles and the other end is connected to the vehicle. (This connector is optional for users)

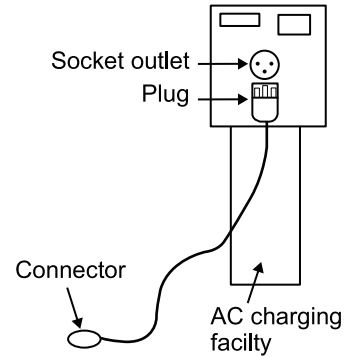

Starting and Driving

3 Direct charging with charging post.

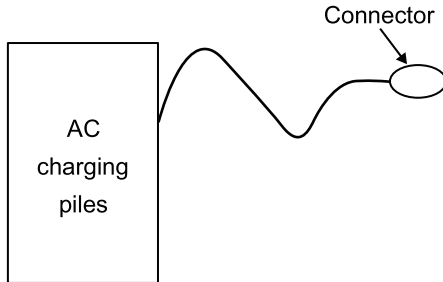

Note: Slow charging is a way of charging high-voltage battery pack to reach the optimal equilibrium state.

To perform a slow charging for the vehicle, turn the power switch off, remove the key, wait for 3 ~ 5 minutes, and then follow the instructions below:

- 1 Select the standard 13A socket (British standard socket) or 16A socket (German standard socket) with reliable earthing or AC charging piles.
 - British standard socket.

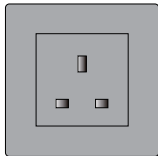

- German standard socket.

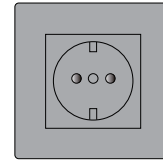

- 2 Take the charging connector out from its package.
- 3 Insert the AC input cable plug of the charging connector into the socket or AC charging piles.
- 4 The charging port is at the left rear side of the vehicle. Gently press the right side of the charging port panel by hand to open the panel.

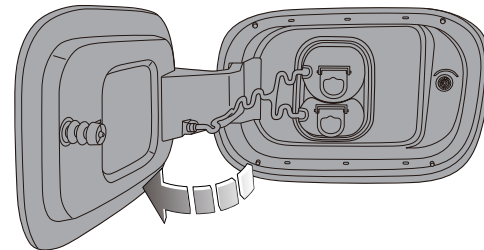

2

Starting and Driving

- 5 Open the cover on the charging inlet.

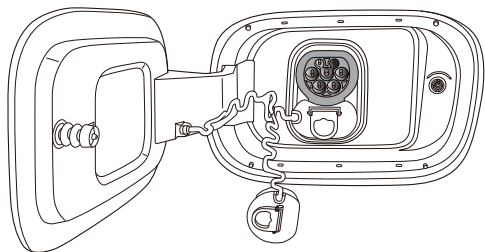

- 6 Connect the charging connector to the charging inlet.

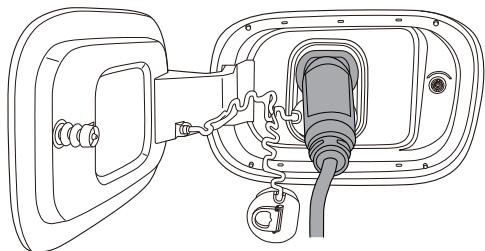

- 7 After the charging connector is properly connected, the "charging connection indicator (red)" on the instrument cluster comes on and the electronic lock of the charging inlet is enabled, which guarantees that the charging connector will not be unplugged whilst charging.

Note: Please make sure that the charging connector is fully inserted into the charging stand to avoid that the electronic lock cannot be locked, resulting in charging failure.

- 8 After the above operations are completed, the system will be charged automatically within about 20 seconds.
- 9 During charging, the "charging status indicator (yellow)" on the instrument cluster is on.

Note: After charging is finished, the key will be locked again if the connector is not pulled out. If the key is switch on the position run, you need to be unlocked through the central control.

Note: If charging with a public AC charging pile, connect the charging connector to the charging equipment, and charge according to the instructions on the AC charging pile.

Note: If charging with a public AC charging pile, before charging, check whether there is any abnormality in the charging equipment. In the charging process, the "charging status indicator (yellow)" on the instrument cluster illuminates. If the equipment can't be charged after 3 consecutive attempts, it is recommended to replace the equipment for attempts. If the equipment can be charged after replacement, the previous charging equipment may be damaged.

Starting and Driving

Note: If charging with a public AC charging pile, please check whether the PP and CP pins of the charging connector are rusted. If so, please clean them before charging to prevent charging failure.

- 10 Once the battery is fully charged, the "charging status indicator (yellow)" on the instrument cluster will go out, and the electronic lock of the charging socket will be unlocked automatically. Press the button switch on the charging connector to remove the charging connector.

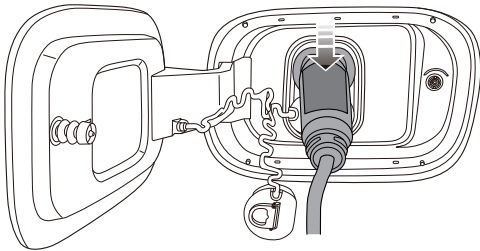

Note: If the charging needs to be ended early and the charging connector be removed, unlock the vehicle with the smart or ordinary key, and the vehicle will stop charging automatically. The "Charging status indicator lamp (yellow)" will go out, and the electronic lock will be unlocked automatically. Then, press the button switch on the charging connector to remove it within 1 minute (if the charging connector is not removed within 1 minute,

the electronic lock of the charging port will be re-locked), and return the power-on switch to the lock position at last.

- 11 Close the cover on the charging inlet.
12 Close the charging port panel.
13 Put the charging connector (suitable for the vehicle model configured with a charging connector) back into the front compartment storage box.

Caution

Emergency treatment: In the event of an emergency such as fire, smoke or burnt smell, turn the socket power switch off immediately to completely power off the system. If the vehicle has been shallowly charged (less than 99%) every two or three times, you need to fully charge (100%) the vehicle once.

Starting and Driving

Caution

- If any unidentified foreign matters are found in the charging plug, insulator, pin and socket, the charging process shall be terminated immediately.
- It is strictly prohibited to insert the charging plug and charging base obliquely.
- It is strictly prohibited to shake the charging plug up, down, left and right when inserting / pulling it out, and it must be inserted / pulled out with vertical force.
- During charging, the cable of charging plug must be smoothed, and it is not allowed to distort to force the charging connector seat during use.
- During the charging process, in case of extremely severe weather such as typhoon, rainstorm and hail, the charging process shall be terminated immediately.
- During the charging process, if the charging interface continuously emits strong and irritating odor, the charging process shall be terminated immediately.

Charging inlet emergency cable

The AC charging socket is provided with the electronic lock function. In the charging process, in order to prevent children from touching or unplugging the charging connector by accident, after the charging connector is plugged into the charging socket, the electronic lock in the charging socket will be locked following the master control switch. At this time, do not unplug the charging connector forcefully to avoid causing damage. Be sure to unlock it using a key or master control switch before unplugging. If the charging connector cannot be unlocked with a key or master control switch in an emergency, open the trunk first, remove the left rear side cover of the vehicle, and then pull the emergency cord downward to unlock the charging connector.

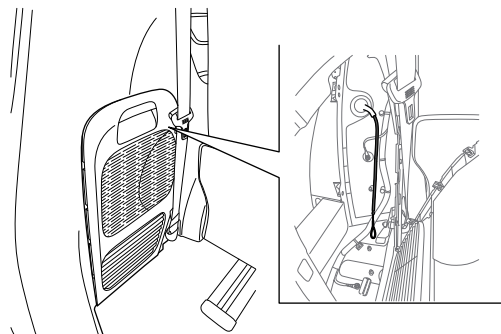

Starting and Driving

Charging information

Rated charging voltage	Charging power	Charging stand standard	Slow charging standard	Fast charging standard	Anti theft of slow charging connector
Max. 470V	Max. 130kW	CCS2	IEC61851	DIN70121	Anti theft

Equalizing charge

Equalization charging refers to Battery Management System enabling basically consistent voltages of all battery cells in the charging process to ensure the overall performance of the high voltage battery pack. It is recommended to use the vehicle at least once every month. It is recommended to slowly charge the vehicle for more than 10 hours every month to extend the life of the high voltage battery pack.

Note: For charging safety reasons, the upper limit of DC fast charging capacity is 97%, and the upper limit of AC slow charging capacity is 100%.

Charging time

Charging time of high-voltage battery pack is related to many factors, such as current electric quantity, charging mode, ambient temperature and charging device power.

Fast charging time

Under the normal temperature state, if the charging equipment has an output capacity of over 130 kW, it will take about 40 minutes to charge the high-voltage battery from 20% to 80%.

Caution

- At a low temperature and in an extremely high temperature environment, the required charging time will be extended.
- If the output capacity of charging device is insufficient, the required charging time will be extended.

Note: In order to protect the high voltage-battery pack and to speed up the temperature rise of the battery, when performing a fast charge in a low temperature environment, the high voltage-battery pack may have a drop in capacity for a short period of time, it is normal.

Starting and Driving

Slow charging time

Under the normal temperature state, it takes about 9.5 hours from the alarm state (the low high-voltage battery pack warning lamp on the instrument cluster illuminates) to the full charge state.

Caution
<ul style="list-style-type: none">• At a low temperature, the required charging time will be extended.• If equalizing charge has not been conducted for a long time, the required charging time will be extended.• Equalizing charge shall be conducted before the first use of long-time parked vehicle, and the charging time shall be appropriately extended to complete the equalizing charge.

Note: *The slow charging time mentioned above means the time required by the vehicle to use AC charging pile for charging. When the residential electricity is used for charging, corresponding charging time will be about 2.5 times of that required for adopting AC charging pile.*

Low speed alarm module

The pure electric vehicle is quiet in low speed driving, resulting in the probability of accidents occurring to pedestrians (especially the blind) higher than that of conventional vehicles. A system making a warning or prompt sound at low speed is achieved via a low speed alarm module (Acoustic Vehicle Alerting System, AVAS) to reduce the probability of accidents occurring to pedestrians. The design of acoustic warning and sound effects for the sound sensitivity of different populations achieves the balance between safety guarantee and noise pollution.

Low speed alarm sound effect

When the vehicle speed is 0-20km/h, the low speed alarm module simulates the sound of running engine to make the sound alarm, and the tone gradually increases with the acceleration and vice versa, to warn persons outside the vehicle about the vehicle passing. The minimum average frequency shift speed of the frequency meets the requirements of no less than 0.8%/(km/h).

Note: When the vehicle speed is 0km/h, the low speed alarm module does not make a prompt sound.

When the vehicle is reversing, the low speed alarm module simulates the sound of running engine to warn persons outside the vehicle about the reversing state, and the tone gradually increases with the acceleration and vice versa.

Note: When the vehicle reversing speed is 0km/h, the low speed alarm module does not make a prompt sound.

Electric power steering system

 **If the electric power steering fails or cannot operate, the steering will appear very heavy, which will affect driving safety.**

The electric power steering system only works when the vehicle is started. The system operates via a motor with assistance levels automatically adjusted based on vehicle speed, steering torque and steering wheel angle.

The electric power steering system has the advantages of simple structure and energy saving. Compared with the traditional hydraulic power steering system, the electric power steering system only needs energy in actual steering, so that power loss can be reduced in this operating way of power consumption according to the need.

Caution

When the electric power steering system operates, holding the steering wheel on full lock for long periods will result in a reduction in power assistance and cause a heavier feel to the steering.

Starting and Driving

EPS (Electric Power Steering) system malfunction warning light

See "Warning lights and indicators" in Before You Drive section. If the battery is disconnected or lacks power seriously, this light may illuminate. At this point, fully turn the steering wheel to the left then the right, thus the system initialization is completed, and the light will go out.

Braking system

Service brake

Dual brake hydraulic system

 **A failure in one of the hydraulic pipelines will be indicated by illumination of the "braking system**

warning light (red)"  on the instrument cluster while driving; it will result in increased brake pedal travel and effort, longer braking distance and may cause the vehicle to pull to one side. Do not pump the brake pedal in an attempt to restore pedal pressure. If there is pressure failure in one of the brake pipelines, the cause must be investigated. IMMEDIATELY bring the vehicle carefully to a halt. Immediately contact our authorized service provider for service. Do NOT continue driving.

Should one of the hydraulic pipelines fail the other circuit will continue to function.

Starting and Driving

General state



Always ensure that floor mats or other objects do not disturb brake pedal movement.

Never rest your foot on the brake pedal as this may overheat the brakes, reduce their efficiency and cause excessive wear. If brake pads/shoes have worn excessively, a squealing or screeching noise will be heard when the brakes are applied, and braking efficiency will be affected. Contact our authorized service provider for service as soon as possible.

If the motor stops running due to some causes, brake booster will stop working after 2 pedal operations; to achieve the expected brake effect, a larger force shall be applied on the pedal. In these circumstances the braking distance may be longer.

If the vehicle is not in regular use or is garaged for long periods, the efficiency of the braking system could be impaired. Contact our authorized service provider for service as soon as possible.

Wet state



Driving in heavy rain and slushy roads will considerably reduce braking efficiency. At this time, keep safe distance from other vehicles and gently depress the brake pedal intermittently to dry the brake friction components. In severe wet weather, this drying process may need to be repeated every few miles.

In winter, ice can form or salt may accumulate on the brake pads and discs. Ice and salt accumulation will be cleaned off after intermittently light applications of the brake pedal.

Descending steep hills



Overheating the brakes will reduce braking efficiency and may also cause the vehicle to pull to one side.

Starting and Driving

ABS (Anti-lock Braking System)

ABS is used to prevent the road wheels from locking under emergency braking, thereby helping you maintain steering control. No special driving technique is needed.

Under normal braking (where sufficient road surface friction exists to prevent wheel lock), the ABS will not be activated.

An integral feature of this braking system is Electronic Brake Distribution (EBD), which is used to optimize the braking force at the rear wheels under full load condition.

Important rules for emergency brake with ABS On:

- 1 Fully depress the brake pedal.
- 2 Bypass the obstacle. No matter how much brake force is used, you can always maintain the control on direction.

ABS Function



ABS may not be able to shorten the brake distance, depending on road surface conditions, brake distance may vary significantly. In fact, when the vehicle without ABS drives on some roads (e.g., gravel road or snowy road), the brake distance may be shorter.

ABS cannot overcome the physical limitations of stopping your vehicle in too short a distance, cornering at high speed, or aquaplaning, i.e. where a layer of water prevents adequate contact between the tires and the road surface.

ABS must never tempt you to take risks that could affect your safety or that of other road users. You still have a duty to drive within normal safety margins, having due consideration for the road surface, weather and traffic conditions.

If the braking force you use exceeds the available adhesion between the tires and the road, causing one or more wheels to be locked, then ABS will automatically come into operation. You will hear the sound of a rapid pulsation which will also be felt through the brake pedal.

When braking in an emergency, always depress full force to the brake pedal, even if the road surface is slippery. ABS is activated; it constantly monitors the speed of each wheel and

Starting and Driving

varies the braking pressure to each according to the amount of friction available.

This prevents the wheels from locking and enables steering control to be maintained.

Precautions for driving a vehicle with ABS

- In an emergency braking situation, depress full force to the brake pedal.
- Under normal braking, apply steady pressure to the brake pedal - DO NOT PUMP IT.
- Remember that steering control will always be available during braking.
- The availability of ABS does not eliminate the dangers of driving too close to the vehicle in front, aquaplaning, excessive cornering speeds, etc.
- ABS does NOT guarantee shorter braking distances.
- Do not be alarmed if you hear and feel a pulsing at the brake pedal. This is normal and indicates that the ABS is in operation.

ESC (Electronic Stability Control)

Functions of ESC

ESC covers the functions of ABS, EBD, TCS, VDC, HBA, RMI, HHC, AUTO HOLD and HDC.

ESC indicator on the instrument cluster flashes when the ESC is operating. You may hear some noise or feel the vibration of brake pedal, which is normal.

When the vehicle is powered on, "ESC indicator (yellow)"



will illuminate and go off after several seconds. In normal driving conditions, ESC indicator keeps off, and ESC is in monitoring state. When the ESC indicator flashes, it indicates ESC is operating. You may hear some noise or feel the vibration of brake pedal, which is a normal phenomenon. In case of ESC failure, ESC indicator will stay On. Please take the vehicle to our authorized service provider for ESC inspection.

ESC switch is located on the central control screen, ESC can be turned off with ESC OFF button, and when ESC function

is turned off, "ESC OFF indicator (yellow)" illuminates and only ABS and EBD functions are available.



EBD (Electronic Brake-force Distribution)

EBD automatically detects the grip conditions between wheels and ground, distributes the brake force optimally to 4 wheels, so as to improve brake efficiency and driving stability.

Starting and Driving

TCS (Traction Control System)

TCS automatically controls the driving force at the start-off and acceleration to prevent wheels from spinning, so as to maintain the driving stability.

VDC (Vehicle Dynamics Control)

VDC is an advanced computer system, which can help you to control the vehicle driving direction in severe driving conditions. When the computer detects the deviation between the expected driving route and the actual driving direction, VDC system may selectively apply brake pressure on one or more brakes of the vehicle so as to keep the vehicle driving in the direction commanded.

HBA (Hydraulic Brake Assist)

In case of emergency braking, usually the driver can step on the brake pedal quickly, but the braking force may not reach the maximum deceleration that the vehicle and the ground can provide. HBA function supports to provide additional braking force in such emergency braking conditions.

RMI (Roll Movement Intervention)

RMI can identify the vehicle rollover trend as early as possible by monitoring the turning angle of steering wheel and lateral acceleration, and apply braking to one or more wheels to prevent the rollover to the greatest extent.

HHC hill hold control

When the vehicle drives uphill, HHC can prevent the vehicle from sliding backwards after the driver releases the brake pedal. An interval up to 2 seconds is available for the driver to shift his foot from the brake pedal to the accelerator pedal so as to successfully drive off on a slope.

AUTO HOLD

The ESC runs together with the EPB to help your vehicle park in any stationary condition without depressing the brake pedal all the time.

HDC (Hill Descent Control)

When the vehicle is running downhill, the HDC function can help the driver keep the speed constant, allowing the driver to focus just on the steering wheel.

Precautions for driving a vehicle with ESC

ESC can detect and analyze vehicle conditions, and take preventive measures by correcting wrong driving operation. However, anything has its limit and no safety device is absolutely safe if the driver blindly drives the vehicle over-speeding.

EPB (Electrical Parking Brake)

The EPB pull-up switch is integrated with the P button on the shift lever. When the vehicle is stationary, press the P button to put the vehicle into P gear while the EPB is pulled up, and there is also an EPB release switch on the center console screen.

Instructions before Using EPB

- Once the vehicle is powered on, the EPB can be used all the time. Do not operate the EPB switch repeatedly when the vehicle is not running to prevent excessive discharging of the battery. EPB is unable to be applied or released when the battery power is insufficient.
- The EPB can prevent accidental slipping when starting off on a slope. The EPB will automatically release only when the vehicle traction is greater than the sliding force.
- When the normal brake of the vehicle fails, the emergency braking function can still stop the vehicle. See "Emergency Braking Function" in this section for details.
- Minor noise may be heard when applying or releasing the electronic parking brake. This is normal, please rest assured.
- When the vehicle is powered off, the applied parking brake cannot be released, and the released parking brake cannot be applied, please connect an external power supply.
- If the "EPB indicator (red)"  does not turn on or off when you operate the EPB switch, or the "EPB malfunction

indicator (yellow)"  illuminates and the EPB cannot be released through normal operation, please contact our authorized service provider.

- Do not perform EPB on the road with the slope more than 30%, otherwise the vehicle may slip. If the EPB fails to fully brake when parking on the road beyond a defined slope, the driver can stop the vehicle from sliding by depressing the brake pedal.

Parking

Manual Hold

- 1 The vehicle is powered on or the motor is operating.
- 2 Keep the vehicle stationary.
- 3 Press the P button on the shift lever and apply the parking brake. If the "EPB indicator (red)" on the instrument cluster illuminates, the parking brake is applied successfully.
Press the P button on the shift lever and apply the parking brake. When the "EPB indicator (red)" on the instrument cluster illuminates, it means the parking brake is successful.
- 4 Move the shift lever in P gear when parking.
- 5 When the vehicle is on a slope, please turn the steering wheel to ensure that the vehicle is aimed at the curb when it slips.

Starting and Driving

Start-off

Manual Release of EPB

- 1 Power on the vehicle.
- 2 Press the EPB release switch on the center console screen.
- 3 Turn off EPB switch to release the parking brake. If the "EPB indicator (red)" on the instrument cluster goes out, the parking brake is released.

Automatic Release of EPB



If a gear is engaged when the vehicle is stopped and the motor is running, never depress the accelerator pedal. Otherwise, the vehicle will immediately move on its own and an accident may occur.

- 1 Power on the vehicle.
- 2 The driver fastens his/her seat belt.
- 3 The transmission is in any gear.
- 4 Depress the accelerator pedal. When starting off on a level ground or a slope, depress the accelerator pedal. When the traction is greater than the sliding force, the parking brake will automatically release, the "EPB indicator (red)" on the instrument cluster will go out, and the vehicle starts to move.

Emergency Braking Function

When the vehicle is in motion, press the P button on the shift lever to activate the emergency braking function. At this time, the

vehicle will brake four wheels by activating the hydraulic brake system, and its braking effect is just like pressing the brake pedal hard. As long as the P button is released, the emergency braking function will be deactivated.

Caution

This function is used when the normal braking operation has failed.

Automatic EPB pull-up function

EPB (Electronic Parking Brake) has flameout power-off automatic pull-up function. You can select to enable the EPB power-off automatic pull-up function on the central control screen by the switch titled "Flameout Automatic Electronic Handbrake Pull-up".

This function is enabled by default, that is, EPB will be automatically pulled up when the vehicle is powered off in flameout state. If you select to disable this function, it will take effect only in current ignition cycle. In next ignition cycle, this function will automatically restore as enabled.

When this function is disabled, you need to power off in P gear to ensure that EPB will not be automatically pulled up. Refer to the following processes for the operation steps:

- 1 Park the vehicle stably and engage in P gear;
- 2 Click the button on the central control screen to release EPB;

Starting and Driving

- 3 Click the button on the central control screen to disable the function;
- 4 Shut down the engine and power off, lock the vehicle and get off.

Caution

When the function is disabled, be sure to park the vehicle on flat ground to ensure safe parking.

AUTO HOLD

AUTO HOLD is located on central control screen. Use this switch to control the on or off of AUTO HOLD system.



The AUTO HOLD system supports the driver to reduce driving fatigue when the vehicle often encounters traffic lights or stops and goes repeatedly. The Auto Hold function enables the parking brake to release automatically when starting off, and the vehicle to park automatically when it is stationary.

2

AUTO HOLD ON

Caution

These conditions may be required to enable AUTO HOLD function: the driver's door is closed; the driver's seat belt is fastened; the motor is started.

When the AUTO HOLD switch is turned on, the "AUTO HOLD indicator (gray)"  on the instrument cluster will illuminate. When the vehicle is stationary and the "AUTO HOLD indicator (green)" on the instrument cluster illuminates, if AUTO HOLD is operating, first perform ESC to hold pressure and stop vehicle. 10 minutes later, if the vehicle is still in stationary state, ESC will request for EPB. The "AUTO HOLD indicator (gray)" goes out, and the "EPB indicator (red)"  illuminates.

Starting and Driving

During operation of the AUTO HOLD, opening the door or unfastening the seat belt will activate the EPB. The "AUTO HOLD indicator (green)" goes out and the "EPB indicator (red)" illuminates.

If you depress the accelerator pedal as usual, the parking brake will be automatically released and the vehicle will start. The "AUTO HOLD indicator (gray)" on the instrument cluster illuminates, and the AUTO HOLD is in standby state.

Disable AUTO HOLD

When the AUTO HOLD switch is turned off, the "AUTO HOLD indicator (gray)" on the instrument cluster will go out, and the AUTO HOLD function is disabled.

 **Do not perform auto hold on the road with the slope more than 30%, otherwise the vehicle may slip.**

When the "AUTO HOLD indicator (yellow)"  on the instrument cluster illuminates, it means the AUTO HOLD system is faulty, please drive immediately to our authorized service provider for vehicle inspection.

HDC (Hill Descent Control)

When driving on a long downhill road with a relatively great gradient, if the vehicle speed is within a certain speed range, there is no need for the driver to depress the brake pedal and accelerator pedal, and the vehicle will run at a low speed

automatically, so as to ensure the vehicle goes downhill steadily; at this time, the driver can correct the automatically controlled speed of system through brake pedal and accelerator pedal.

HDC is located on central control screen. Use this switch to control the on or off of HDC system.

When the vehicle speed is within the range of 35 - 60 km/h, HDC is inoperative but in standby state.

When the vehicle speed is higher than 60 km/h, HDC function automatically exits. To enable it again, you need to press the HDC switch on central control screen again.

When the vehicle is powered on, HDC function is disabled by default. When the HDC switch is turned on, "HDC indicator

(green)"  on the instrument cluster illuminates, and HDC function is in standby state. When HDC operates, "HDC indicator (green)" will flash; if "HDC indicator (yellow)" illuminates, it indicates the HDC system is faulty. Please drive the vehicle to our authorized service provider for ESC system inspection. When the HDC switch is turned off, the "HDC indicator (green)" on the instrument cluster will go out, and the HDC function is disabled.

Note: HDC function is used to assist the driver to go downhill steadily at a low speed, and it is not recommended to enable this function on a non-ramp road.

Warning lights

Warning lights related to braking system include "braking system warning light (red)", "ABS warning light (yellow)", "EBD warning light (red)", "ESC indicator (yellow)", "ESC OFF indicator (yellow)", "EPB indicator (red)", "EPB malfunction warning light (yellow)", "AUTO HOLD indicator (gray)", "AUTO HOLD indicator (green)", "AUTO HOLD indicator (yellow)", "HDC indicator (green)" and "HDC indicator (yellow)", please see "Warning lights and indicators" in Before You Drive section.

Brake pedal sensing mode switching function

The vehicles with electronic control booster is preset with two brake pedal sensing mode: "standard" and "sports", and the driver can select and switch between these two modes on the central control screen.

When the "sports" modes is selected, a small pedal force or pedal stroke can not only obtain larger braking force, but also reach the maximum point of booster force in a short time and shorten the braking distance. This mode is applicable to old or female drivers with small stepping force.

When the "standard" mode is selected, the braking force output is relatively moderate at the same pedal force or pedal stroke, which is applicable to the vast majority of people.

Note: *When switching brake pedal sensing mode, ensure that the vehicle starts from a stationary state and the brake pedal cannot be stepped on.*

Parking assist system

Note: *The type of parking assist system equipped on your vehicle is subject to the actual vehicle configuration purchased.*

Camera provides visual aids for the parking assist system. See "Camera" in Driver assistance system for details. Ultrasonic radar provides object detection for the parking assist system. See "Radar" in Driver assistance system for details.

2

Parking sensor

 **The parking assist system is not always reliable and is only playing the role of guidance! The parking sensors might not detect some types of obstacles, including slim objects (such as wire nets and ropes), small objects close to the ground, conic objects and some objects with non-reflective surfaces.**

The sensors shall be free of dirt, ice, and snow. The sediment on surfaces of sensors will impair the normal functioning of the sensors. Therefore, avoid directly flushing the sensors from a short distance by a high pressure water gun while washing your vehicle.

The sensors installed on the rear bumper are functioned to scan the rearward area of vehicle, in order to judge the presence of obstacles. Upon detection of any obstacle, the parking sensors

Starting and Driving

will calculate its spacing from the rear of the vehicle and send the information to the driver by alerting tones. It's really important that this system is only a parking assist system and can't function as the replacement for your observation and personal judgment.

Working status of parking sensor assist system

After selecting the reverse gear, the parking assist system will give out a prompt tone of 0.5s to indicate the operation started automatically. When selecting other gears, the parking assist system will stop working.

Note: If the system gives out a prompt tone of 3s after the reverse gear is selected, it indicates that the system has a malfunction. Contact Our Service Dealer for service as soon as possible.

Parking process

When the two middle radars in the rear of the vehicle are about 150cm away from the barrier, or when the radars on both sides are about 60cm away from the barrier, the parking assist system starts to make alarm sounds. And the alarm sound become harsher when the vehicle is approaching the barrier.

When the distance of the vehicle from the barrier is less than 30cm, the parking assist system will sound a long alarm. At this moment, it is impossible to effectively identify the barrier if you continue to reverse the vehicle.

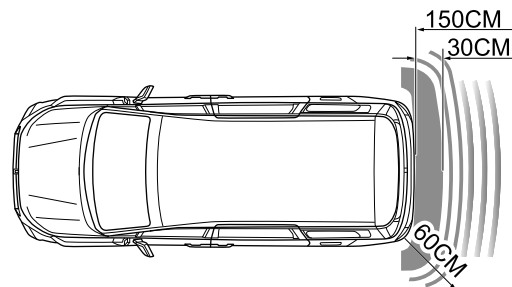

Front and rear sensors



The parking assist system is not always reliable and is only playing the role of guidance! The sensors might not detect some types of obstacles, including slim objects (such as wire nets and ropes), small objects close to the ground, conic objects, and some objects with non-reflective surfaces.

The sensors shall be free of dirt, ice, and snow. The sediment on surfaces of sensors will impair the normal functioning of the sensors. Therefore, avoid directly flushing the sensors from a short distance by a high pressure water gun while washing your vehicle.

The radar sensor located in the front bumper will scan the front area of the vehicle, and the radar sensor located in the rear bumper will scan the rear area of the vehicle, in order to judge the presence of obstacles. Upon detection of any obstacle, the parking sensors will calculate its spacing with the vehicle and send the information to the driver by alerting tones. It's really important that this system is only a parking assist system and can't function as the replacement for your observation and personal judgment.

Working status of parking assist system with front and rear sensors

Rear parking assist system

After selecting the reverse gear, the parking assist system will give out a prompt tone of 0.5s to indicate the operation started automatically. After shifting out of the reverse gear, the rear parking assist system stops working.

Front parking assist system

When selecting the reverse gear or the drive gear, the vehicle speed rises from 0km/h to 15km/h, the front parking assist system works; when the vehicle speed drops from 15km/h to 12km/h, the front parking assist system is in standby mode; when the vehicle speed drops to 12km/h or below, the front parking assist system works.

Note: If the system keeps ringing for a long time after the reverse gear or the drive gear is selected, it indicates that the system has a malfunction. Contact Our Service Dealer for service as soon as possible.

Front radar switch on center console screen

Press the front radar switch on center console screen to turn on the front parking assist system.

Starting and Driving

Parking process

When the two middle radars in the rear of the vehicle are about 150cm away from the barrier, or when the radars on both sides are about 60cm away from the barrier, the parking assist system starts to make alarm sounds. And the alarm sound become harsher when the vehicle is approaching the barrier.

When the radars on both sides of the front of vehicle are about 60cm away from the barrier, the parking assist system will start making alarm sounds. And the alarm sound become harsher when the vehicle is approaching the barrier.

Note: For the vehicles equipped with automatic parking assist system, when the two middle radars in the front of the vehicle are about 120cm away from the barrier, the parking assist system will start making alarm sounds.

When the distance of the vehicle from the barrier is less than 30cm, the parking assist system will sound a long alarm. At this moment, it is impossible to effectively identify the barrier if you continue to reverse the vehicle.

Note: When the distance of the vehicle from the barrier is more than 30cm, the front radar has a mute strategy of 3s with the vehicle in drive gear; if the distance from the barrier does not change after 3s, the alarm sound will stop; if the distance from the barrier changes again, the system will resume sending alarm sound.

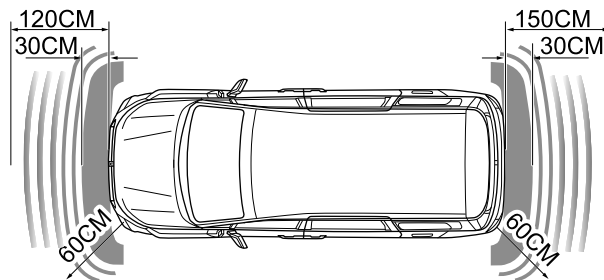

Rear view camera

! The parking camera assist system is not always reliable and is only playing the role of guidance! Due to limited visual field, the parking camera can't detect any obstacle beyond its visual field.

Working status of parking camera assist system:

After selecting reverse gear, the image of center console screen will be switched to the working status of parking camera, and the display will show the scene image behind the vehicle for the driver's reference during reversing.

When selecting other gears, the parking camera assist system stops working and the display returns to the original state.

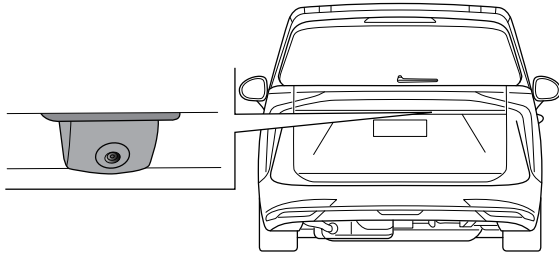

Note: When the vehicle enters the reversing state, cameras will output static reversing tracks which are displayed on the center console screen, take the horizontal plane as reference, and identify the area behind the vehicle in segments divided by red, yellow and green lines.

360° around-view system

! The parking assist system is not always reliable and is only playing the role of guidance! Due to limited visual field, the parking camera can't detect any obstacle beyond its visual field.

The 360° around-view system includes 4 cameras, which are respectively installed in the front, rear, left and right of vehicle body.

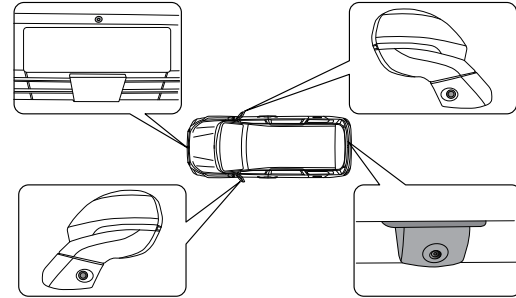

Operating state of 360° around-view system:

After selecting the reverse gear, the center console screen will automatically switch to the 360° around-view interface, and then you can judge the relative position between the vehicle and the barrier according to the image.

When the vehicle speed is less than 15km/h, press the 360° around-view button on the center console screen to turn on the 360° around-view system. Then the center console screen will switch to the 360° around-view interface of left turn, right turn or normal driving according to the current vehicle operation.

Note: Select the area to be viewed by touching the front, rear, left or right button on the center console screen.

Starting and Driving

540° around-view system

! 540° around-view system is not always reliable. It only plays the role of assistance! Due to limited visual field, the camera can't detect any obstacle beyond the blind spot and its visual field; even when the system is running, be also careful to view the environment around the vehicle.

540° around-view system includes four cameras and one controller, and the cameras are respectively located in four orientations of front, rear, left and right.

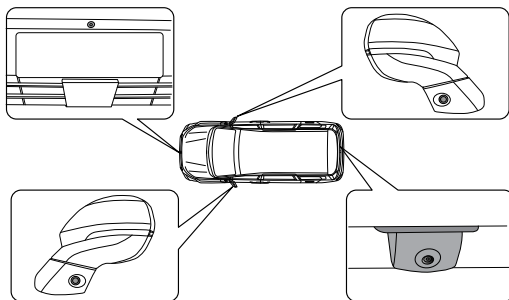

540° around-view system provides multiple auxiliary functions, which mainly include:

- 2D image
- 3D viewing angle
- Viewing angle of underbody

Note: The type of 540° around-view system on your vehicle depends on the actual vehicle configuration you purchased.

2D/3D around-view system

Function activation

- Select the reverse gear to trigger the around-view system.
- When the vehicle speed is less than 15km/h, wake up the panoramic system through "360" icon on the main interface of center console screen.

After the function is activated, 2D/3D and front/rear/left/right viewing angles can be switched in the operation area.

Function deactivation

- Click "X" at the top left corner of screen under the panoramic interface to deactivate it.
- When the vehicle speed is 17km/h or above, the system automatically exits.

Function settings

Click the "Settings" on the screen under the panoramic interface, and users can choose to activate/deactivate the sub-functions such as "steering triggered panorama", "forward trajectory" and "wide viewing angle".

Starting and Driving

Viewing angle of underbody

The viewing angle of underbody can provide the visual field from underbody, such as observe the manhole cover, curb and tire returnability.

Function activation

Click the "viewing angle of underbody" on the screen under the panoramic interface to enter the interface for viewing angle of underbody, which is front view angle by default.

Function deactivation

- Click "2D image" or "3D viewing angle" to switch out of the viewing angle of underbody.
- Click "X" at the top left corner of screen to deactivate it.
- When the vehicle speed is 30km/h or above, the system automatically exits.

Driver assistance system

Note: The type of advanced driver assistance system on your vehicle depends on the actual vehicle configuration you purchased.

Camera

This vehicle is equipped with five types of cameras: surround view camera, smart sideview camera, interior camera, front view camera or front tri-focal camera. The surround view camera provides visual assist for the parking assist system. The interior camera provides object detection for the driver/occupant monitoring system. The smart sideview camera, front view camera or front tri-focal camera provides object detection for the driver assistance system.

Camera mounting location

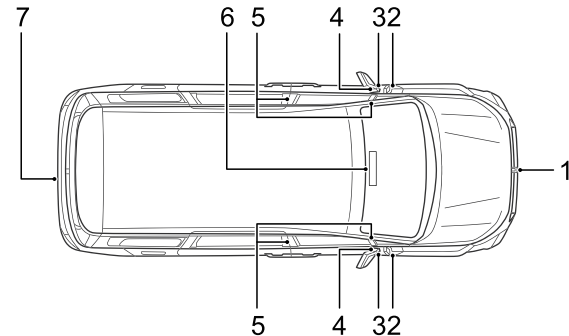

Starting and Driving

- 1 The front surround view camera is mounted on the front grille.
- 2 The left rear/right rear smart sideview cameras are mounted on the front fenders.
- 3 The left front/right front smart sideview cameras are mounted on the outer side of the roots of left and right rearview mirrors.
- 4 The left and right surround view cameras are mounted on the inner side of the roots of left and right rearview mirrors.
- 5 The interior cameras are mounted below the A-pillar upper trim panel and above the B-pillar upper trim panel.
- 6 The front view camera or front tri-focal camera is mounted inside the windshield, at the interior rearview mirror. (Some models are equipped with a front view camera, while others are equipped with a front tri-focal camera, both of which will not be mounted in the same model)
- 7 The rear surround view camera is mounted near the license plate light on the right of the tailgate.

Note: *The type and location of cameras on your vehicle depends on your actual vehicle configuration.*

Caution

When the camera sensor hardware is damaged, it must be repaired or replaced timely. It is recommended that you drive your vehicle to Our Service Dealer for repair, instead of replacement by yourself.

No license plate frame and other items are allowed on the front and rear license plates to prevent interference with cameras or radar sensors; the license plates requires regular maintenance and service to prevent their deformation from affecting the performance of radar sensors.

The cameras may not work properly in all traffic environments, weathers, and driving conditions. Please drive with care when the driving environment is complex or the weather condition is bad.

Camera maintenance

In order to ensure normal operation, please keep the front of the cameras free of foreign matters such as dust, ice, snow, and water.

When there are foreign matters in front of the radar, please clean it with a soft cloth. Do not use a high pressure water gun, nor damage the lens of the camera.

The assembled structure after camera replacement must use our original parts. The camera must be re-calibrated at Our Service Dealer after replacement to ensure that all camera-based vehicle systems function properly.

Starting and Driving

Usage restrictions

When a camera cannot work properly, the functions that rely on the detected information provided by the camera are limited or abnormal.

The detection range and capability of the cameras are limited, and the objects beyond their detection range and capability cannot be detected.

The camera performance will be inhibited in the following environments:

- Camera view blocked or foreign matters adhering to the camera surface, such as dust, ice, snow, and water.
- Weather conditions with poor lights or low visibility.
- Camera overexpose caused by direct sunlight.
- Rapid change in lights (e.g. driving into or out of a tunnel).
- Camera shake due to bumpy road or other reasons.

Radar

This vehicle is equipped with two types of radar: ultrasonic radar and millimeter wave radar. The ultrasonic radar provides object detection for the parking assist system. The millimeter wave radar provides object detection for the driver assistance system.

Radar mounting location

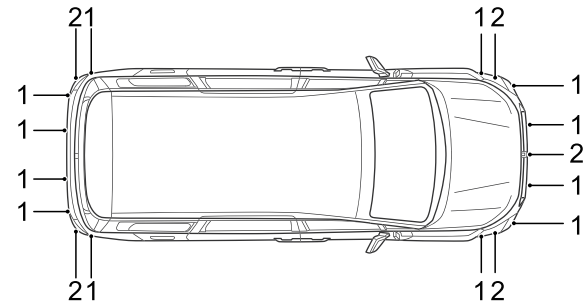

- 1 The ultrasonic radars are mounted on the front and rear bumpers.
- 2 The millimeter wave radars are mounted inside the front grille/in the front and rear bumpers. (Some models are only equipped with millimeter wave radars inside the front grille, while others are equipped with 5 millimeter wave radars)

Note: *The type and location of radars on your vehicle depends on your actual vehicle configuration.*

Starting and Driving

Caution

In order to avoid the influence on the detection performance of radar sensors, it is strictly prohibited to paint or modify the body and front and rear bumpers without permission.

When the radar sensor hardware is damaged, it must be repaired or replaced timely. It is recommended that you drive your vehicle to Our Service Dealer for repair, instead of replacement by yourself.

No license plate frame and other items are allowed on the front and rear license plates to prevent interference with cameras or radar sensors; the license plates requires regular maintenance and service to prevent their deformation from affecting the performance of radar sensors.

The radar sensors may not work properly in all traffic environments, weathers, and driving conditions. Please drive with care when the driving environment is complex or the weather condition is bad.

Radar maintenance

In order to ensure normal operation, please keep the front of the radars free of foreign matters such as dust, ice, snow, and water.

When there are foreign matters in front of the radar, please clean it with a soft cloth. Do not use a high pressure water gun, nor damage the front surface of the radar.

The assembled structure after radar sensor replacement must use our original parts. The radar sensor must be re-calibrated

at Our Service Dealer after replacement to ensure that all radar sensor-based vehicle systems function properly.

Usage restrictions

When a radar cannot work properly, the functions that rely on the detected information provided by the radar are limited or abnormal.

The detection range of the radars is limited, and the objects beyond their detection range cannot be detected.

The radar performance will be inhibited in the following environments:

- Foreign matters adhering to the radar surface, such as dust, ice, snow, and water.
- Absorbing interfering substances on the objects detected by the radar, such as cotton objects.
- Bad weather conditions, such as heavy rain, heavy snow and dense fog.
- Radar shake due to bumpy road or other reasons.

Starting and Driving

FCW and AEB (Forward collision assist)

The forward collision assist includes FCW (Forward Collision Warning) and AEB (Automatic Emergency Braking). The forward collision warning function warns the driver of pedestrians, bicycles or vehicles in front of the vehicle with visual and audio signals. If the driver fails to take actions within a reasonable period of time, the system will trigger the automatic emergency braking function.

The collision assist may enable rapid and momentary braking in response to different risks of collision, which may make the driver uncomfortable, and the driver should actively apply brake at this time.

If the risk of collision further increases, the system will brake sharply and stop the vehicle under normal conditions. For most drivers, this is not a normal driving style and they may feel uncomfortable. When the collision assist successfully avoids collision with the vehicle ahead, the vehicle will remain stationary for a short period of time and the driver should take actions as soon as possible.

The driver or occupant usually notices the function of collision assist only when the vehicle is about to collide. The collision assist is activated when the driver should start braking early, but it cannot assist the driver in all cases.

Function activation or deactivation

Function activation method

When the vehicle is started, the collision assist function is activated by default.

To reactivate the function after you deactivate it, set on the center console screen: Settings -> Advanced Driver Assistance -> Activate Collision Assist.

When the function is activated, the "FCW (Forward Collision Warning)/AEB (Automatic Emergency Braking) warning light

(yellow)"  on the instrument cluster is turned off.

Function deactivation method

Set on the center console screen: Settings -> Advanced Driver Assistance -> Deactivate Collision Assist.

When the function is deactivated, the forward collision warning and automatic emergency braking will be turned off at the same time, and the "FCW (Forward Collision Warning)/AEB

(Automatic Emergency Braking) warning light (yellow)"  on the instrument cluster remains on.



Sensitivity adjustment

Set on the center console screen by clicking "... " or ">" on the right of Collision Assist to pop up the options "Low", "Standard"

Starting and Driving

and "High"; you can choose the appropriate sensitivity based on your needs.

Information prompts

- Visual alarm
 - Indicator prompt: During the forward collision warning, the "FCW (Forward Collision Warning)/AEB (Automatic Emergency Braking) warning light (yellow)"  flashes; during the automatic emergency braking, the "FCW (Forward Collision Warning)/AEB (Automatic Emergency Braking) warning light (red)"  flashes.
 - Text reminder: Risk of collision/automatic emergency braking.
- Audible alarm: The entertainment system speaker alarms.

Caution

The collision assist is an auxiliary function that cannot work under all driving, traffic, weather and road conditions, which cannot replace the driving and accurate judgment. The performance of the system may be degraded by other factors, so that the driver should drive carefully and do not rely solely on the system. Before using the collision assist, the driver should check the restrictions they need to know by referring to this section.

Caution

The collision assist is designed to decrease the vehicle speed as much as possible to reduce the losses caused by collisions, instead of complete prevention of collisions. The driver should drive carefully and do not rely on the system.

When the system gives visual and audible warnings, the driver should immediately take further measures to avoid risk of collision and do not rely solely on the system.

The recognition range of front view camera and front millimeter wave radar realized by collision assist is limited, so you should not rely solely on the system to prevent collisions.

Due to the inherent limitations, the system may give a warning or brake when there is no risk of collision. The driver should always pay attention to the traffic environment ahead and take appropriate measures immediately.

The operating range of the collision assist system is 8 km/h to 130 km/h.

With the collision assist activated, if the "FCW (Forward Collision Warning)/AEB (Automatic Emergency Braking)

warning light (yellow)"  remains on, please drive to Our Service Dealer for service.

Usage restrictions

- When the vehicle speed is less than 8 km/h, the system will not give an alarm. Lower speed may indicate that you are

driving on a congested road and the occasional triggering of the system may provide bad driving experience.

- The driver should ensure that the seat belt has been fastened, otherwise the automatic emergency braking will not work.
- Please ensure that the electronic stability control and collision assist functions are activated, otherwise the collision assist function will not work.
- Certain objects will affect and impair the detection of sensors, such as road fences, tunnel entrances, heavy rain or snow, which may in turn affect the related functions of the AEB.
- The prerequisite for the collision assist to respond to a relevant object is that it must be in the sensor view and recognized. The collision assist performance will be greatly limited for objects that cut in, are detected only after the vehicle changes its lane, and are on roads with sharp turns.
- If traffic conditions or external influences cause the cameras and radars failure to properly detect the pedestrians, cyclists, vehicles and other objects, warning or brake intervention may be delayed or not fully implemented.
- The detection capability of cameras will be affected by severe weathers, such as high wind, heavy rain, dense fog, etc., which will reduce the system performance or increase the false trigger rate.
- See "Camera" for camera restrictions.
- See "Radar" for radar restrictions.

LDW (Lane Departure Warning)

The LDW (Lane Departure Warning) function assists the driver on highways, expressways and other similar main roads. When the driver departs from the lane unintentionally, it warns and prompts the driver to return to the current lane, thereby avoiding traffic accident.

The lane departure warning function is activated when the vehicle speed is greater than or equal to 60 km/h and the road markings are clearly visible.

When the vehicle is driven at low speed or actively (judged by turning on the turn signal/rapid lane change, etc.), the system will not give an alarm.

Function activation or deactivation

Function activation method

When the vehicle is started, the lane departure warning function is activated by default.

To reactivate the function after you deactivate it, set on the center console screen: Settings -> Advanced Driver Assistance -> Activate Lane Keeping Assist.

Function deactivation method

Set on the center console screen: Settings -> Advanced Driver Assistance -> Deactivate Lane Keeping Assist.

When the function is deactivated, the "LDW (Lane Departure Warning)/LKA (Lane Keeping Assist)/ELK (Emergency Lane

Starting and Driving

Keeping) warning light (yellow)"  on the instrument cluster remains on.

Sensitivity adjustment

Set on the center console screen by clicking "... " or ">" on the right of Lane Keeping Assist to pop up the options "Low", "Standard" and "High"; you can choose the appropriate sensitivity based on your needs.

Information prompts

When the driver departs from the lane unintentionally, the system will remind the driver through the warning icon on the instrument cluster, accompanied by the sound of the buzzer, and the lane line on the corresponding side on the instrument cluster is displayed in red. This means that the vehicle is at risk of departing from the lane. In this case, the driver should correct the vehicle to return to the current lane immediately.

Caution

The lane departure warning is only an alarm-assisted driving function.

The driver should not rely solely on the lane departure warning function to remind the departure, and should bear the responsibility for safe driving.

The lane departure warning cannot work under all driving or traffic, weather and road conditions.

Caution

When the lane keeping assist system fails, i.e. after the lane keeping assist function is activated, the "LDW (Lane Departure Warning)/LKA (Lane Keeping Assist)/ELK

(Emergency Lane Keeping) warning light (yellow)"  remains on, please drive to Our Service Dealer for service.

Usage restrictions

The lane departure warning cannot clearly detect lane lines at all times. You may receive useless or invalid warning under the following conditions:

- In road construction areas, at sharp turns or on narrow roads.
- Darkness (poor lighting) or weather conditions (due to heavy rain, heavy snow, dense fog or high wind).
- The recognition capability of the camera is deteriorated under direct sunlight or oncoming strong light.
- The vehicle ahead is large or close, blocking the camera view.
- Blocked windshield within the camera view (water mist, dust, or sticker, etc.).
- The width and quality of lane lines fail to meet the requirements, such as lane lines worn or covered, presence of both old and new lane lines, or lane lines changed by construction sections.
- Large shadows are projected on the lane by trees, large objects, or landscape features, etc.

- The lane departure warning may miss a warning or give a false warning under the following conditions:
 - See "Camera" for camera restrictions.
 - Weather conditions (heavy rain, snow, fog, extremely high or low temperatures) interfere with camera operation.

The above warnings and restrictions do not include all conditions that may interfere with lane departure warning. Many factors may cause the lane departure warning to be inoperative. In order to avoid departure, the driver should remain vigilant and always pay attention to the road conditions, so that corrective measures are taken as soon as possible.

LKA (Lane Keeping Assist)

When the LKA (Lane Keeping Assist) function is activated, it determines the position of the vehicle relative to the lane lines based on the road boundary information obtained by the cameras, and shall warn the driver or return the vehicle to the lane by steering intervention in combination with the vehicle status and driver input if the driver departs from the lane unintentionally. This is a safety function that only corrects the deviation when the vehicle is about to deviate from the lane, not a comfort function of lane centering type, so the driver should firmly hold the steering wheel at all times during use.

The lane keeping function is activated when the vehicle speed is between 60 km/h and 120 km/h and the road markings are clearly visible.

When the vehicle is driven at low speed or actively (judged by turning on the turn signal/rapid lane change, etc.), the system will not give an alarm or automatically intervenes in steering.

Function activation or deactivation

The LKA (Lane Keeping Assist) shares the switch of LDW (Lane Departure Warning), and its specific operations are shown in "LDW (Lane Departure Warning)" in this section.

Information prompts

When the driver departs from the lane unintentionally, the system will remind the driver through the warning icon on

Starting and Driving

the instrument cluster and the sound of the buzzer, and may intervene in steering to return the vehicle to the current lane.

Caution

The lane keeping assist is just a driver assistance function. The driver should not rely solely on the lane keeping assist function to prevent departure from the lane, and should bear the responsibility for safe driving. The driver should follow the traffic regulations and hold the steering wheel firmly with both hands. If the driver does not hold the steering wheel, the system will not provide the keeping assist function.

The lane keeping assist will not always help the driver to correct the vehicle with a tendency of departure, and the driver must take over the vehicle after correction to ensure that the vehicle is stable. The lane keeping assist cannot work under all driving or traffic, weather and road conditions.

When the lane keeping assist system fails, i.e. after the lane keeping assist function is activated, the "LDW (Lane Departure Warning)/LKA (Lane Keeping Assist)/ELK

(Emergency Lane Keeping) warning light (yellow)"  remains on, please drive to Our Service Dealer for service.

If the vehicle suspension kit replaced by yourself is not approved by us, the lane keeping assist system may not operate properly.

Usage restrictions

The lane keeping assist cannot clearly detect lane lines at all times. You may receive invalid warning or false interference under the following conditions.

- In road construction areas, at sharp turns or on narrow roads.
- Darkness (poor lighting) or weather conditions (due to heavy rain, heavy snow, dense fog or high wind).
- The recognition capability of the camera is deteriorated under direct sunlight or oncoming strong light. The vehicle ahead is large or close, blocking the camera view. Blocked windshield within the camera view (water mist, dust, or sticker, etc.).
- The width and quality of lane lines fail to meet the requirements, such as lane lines worn or covered, presence of both old and new lane lines, or lane lines changed by construction sections. Large shadows are projected on the lane by trees, large objects, or landscape features, etc.
- The lane keeping assist may miss a warning or give a false warning under the following conditions:
 - See "Camera" for camera restrictions.
 - Weather conditions (heavy rain, snow, fog, extremely high or low temperatures) interfere with camera operation.

The above warnings and restrictions do not include all conditions that may interfere with lane keeping assist. Many factors may cause the lane keeping assist to be inoperative. In order to avoid departure, the driver should remain vigilant and always pay attention to the road conditions, so that corrective measures are taken as soon as possible.

Starting and Driving

ELK (Emergency Lane Keeping)

When the ELK (Emergency Lane Keeping) function is activated, it determines the position of the vehicle relative to the adjacent vehicle or curb, etc. based on the road environment information obtained by the front cameras and corner millimeter wave radars, and will warn the driver or keep the vehicle away from the risk of collision by steering intervention in combination with the vehicle status and driver input if the driver departs unintentionally, causing risk of collision with the adjacent vehicle or curb, etc. This is a safety function, not a comfort function.

The lane keeping function is activated when the vehicle speed is between 60 km/h and 120 km/h and the road markings are clearly visible.

When the vehicle is driven at low speed or actively (judged by turning on the turn signal/rapid lane change, etc.), the system will not give an alarm or automatically intervenes in steering.

Function activation or deactivation

The ELK (Emergency Lane Keeping) shares the switch of LDW (Lane Departure Warning), and its specific operations are shown in "LDW (Lane Departure Warning)" in this section.

Information prompts

When the driver departs unintentionally and there is a risk of collision with the adjacent vehicle or curb, etc., the system will remind the driver through the warning icon on the instrument cluster and the sound of the buzzer, and may intervene in

steering to keep the vehicle away from the adjacent vehicle or curb, etc. to avoid the risk of collision.

Caution

The emergency lane keeping assist is just a driver assistance function. The driver should not rely solely on the emergency lane keeping function to prevent collision with the adjacent vehicle or curb, and should bear the responsibility for safe driving.

The driver should follow the traffic regulations and hold the steering wheel firmly with both hands. If the driver does not hold the steering wheel, the system will not provide the emergency keeping assist function.

The emergency lane keeping assist will not always help the driver correct the vehicle with a tendency to collide with the adjacent vehicle or curb, and the driver must take over the vehicle after correction to ensure that the vehicle is stable.

The emergency lane keeping assist cannot work under all driving or traffic, weather and road conditions.

When the emergency lane keeping assist system fails, i.e. after the lane keeping assist function is activated, the "LDW (Lane Departure Warning)/LKA (Lane Keeping Assist)/ELK

(Emergency Lane Keeping) warning light (yellow)"  remains on, please drive to Our Service Dealer for service.

Starting and Driving

Caution

If the vehicle suspension kit replaced by yourself is not approved by us, the emergency lane keeping assist system may not operate properly.

Usage restrictions

The emergency lane keeping assist cannot clearly detect lane lines at all times. You may receive invalid warning or false interference under the following conditions.

- In road construction areas, at sharp turns or on narrow roads.
- Darkness (poor lighting) or weather conditions (due to heavy rain, heavy snow, dense fog or high wind).
- The recognition capability of the camera is deteriorated under direct sunlight or oncoming strong light.
- The lateral vehicle is large or the vehicle appearance is irregular, and the curb is severely damaged or unconventional, so that the cameras cannot accurately identify it as the object to be avoided.
- Camera view blocked (water mist, dust, or sticker, etc.).
- The width and quality of lane lines fail to meet the requirements, such as lane lines worn or covered, presence of both old and new lane lines, or lane lines changed by construction sections.
- Large shadows are projected on the lane by trees, large objects, or landscape features, etc.
- The emergency lane keeping assist may miss a warning or give a false warning under the following conditions:

- See "Camera" for camera restrictions.
- Weather conditions (heavy rain, snow, fog, extremely high or low temperatures) interfere with camera operation.

The above warnings and restrictions do not include all conditions that may interfere with emergency lane keeping assist. Many factors may cause the emergency lane keeping assist to be inoperative. In order to avoid the risk of collision with the adjacent vehicle or curb, the driver should remain vigilant and always pay attention to the road conditions, so that corrective measures are taken as soon as possible.

ACC (Adaptive Cruise Control)

ACC (Adaptive Cruise Control) can help the driver maintain the same speed as the vehicle ahead for the preselected time interval. The adaptive cruise control system can bring you a more relaxed and comfortable driving experience when driving on smooth expressways and long straight roads. The driver can set the required vehicle speed and the time interval with the front vehicle. When the camera and front millimeter wave radar sensor detect that the vehicle ahead is slowing down, your vehicle will automatically slow down accordingly. When the road ahead is clear again, your vehicle will be restored to the selected speed.

Adaptive cruise control switch

The adaptive cruise control switches are located on the steering wheel and shift lever.

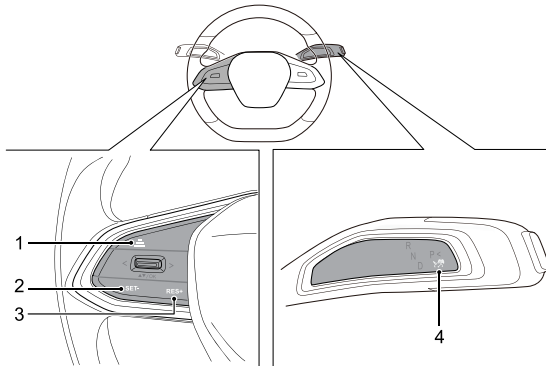

- 1 : To set the following distance, adjust the following distance of the adaptive cruise control, and switch the following distance from Level 1 to Level 3 cyclically for each press.
- 2 SET-: To decrease the cruise speed.
- 3 RES+: To increase the cruise speed.
- 4 : Adaptive cruise control switch; if the conditions are met, move the shift lever down to the bottom and release it to activate the ACC (Adaptive Cruise Control) function.

2

Activation of adaptive cruise control

When an object is detected ahead after the vehicle is started, the cruise control function can be activated at any speed; if no object is detected ahead, the vehicle speed should be kept above 15 km/h before you can activate the cruise control function.

When the "ACC (Adaptive Cruise Control) indicator (gray)" on the instrument cluster illuminates, you can use the adaptive cruise control function, which is in standby state.

In this state, you can move the shift lever down to the bottom and release it to activate the ACC (Adaptive Cruise Control) function.

When the ACC (Adaptive Cruise Control) function is activated, the "ACC (Adaptive Cruise Control) indicator (blue)" on the instrument cluster illuminates.

Starting and Driving

After the system is activated, the vehicle will cruise at the set cruise speed when there is no vehicle ahead; when there is a target vehicle ahead, and its speed is greater than the set cruise speed of the vehicle, the system will allow the vehicle to continue driving at the current cruise speed; when its speed is less than the set cruise speed of the vehicle, the system will actively adjust the speed to maintain the set following time interval from the vehicle ahead to achieve automatic following. When the vehicle ahead accelerates, the system will also actively accelerate until the set cruise speed is restored.

The ACC (Adaptive Cruise Control) will intelligently limit the speed on curves.

Adjustment of cruise speed

When the ACC (Adaptive Cruise Control) is activated, the cruise speed can be increased or decreased through RES+ and SET-.

Short press RES+/SET- to change the cruise speed by 5 km/h.

Long press RES+/SET- to change the cruise speed by 1 km/h.

With the ACC (Adaptive Cruise Control) in the override state, press the SET- button to synchronize the speed, i.e. the cruise speed becomes the current actual speed.

Cruise speed memory

To use the previous cruise speed when activating the cruise control, move the shift lever down to the bottom for more than 1 second, and then release it.

Adjustment of cruise distance

Short press the  to switch the following distance from Level 1 to Level 3 cyclically for each press, and the current cruise distance can be confirmed through the display on the instrument cluster.

Deactivation of adaptive cruise control

To manually deactivate the cruise control, pull up the shift lever or shift the gear, and depress the brake pedal. When the cruise control is deactivated, the ACC (Adaptive Cruise Control) indicator will change from blue to gray, or the ACC (Adaptive Cruise Control) indicator will go out.

Restoration of adaptive cruise control

To use the previous cruise speed when activating the cruise control, move the shift lever down to the bottom for more than 1 second, and then release it.

When cruising at the current speed, the adaptive cruise control can be restored by activating it.

The system will enter the function hold state and will not be restored under the following conditions, and the instrument cluster will provide the relevant information to indicate the need to restore cruise control:

- The follow and stop time exceeds 180 seconds.
- The ultrasonic radar detects pedestrians ahead.

Starting and Driving

Caution

The driver must always pay attention to the current traffic conditions and intervene when the adaptive cruise control system fails to maintain a proper speed or a correct distance. The adaptive cruise control system is unable to deal with all traffic, weather and road conditions.

The ACC is not a safety system, obstacle detector or collision warning system, but a comfort system. The driver must maintain control of the vehicle at all times and take full responsibility for the vehicle.

The function of ACC can assist the driver, but cannot replace the driver in driving. The driver must drive carefully and follow the speed limit regulations even when the ACC is activated.

If the driver depresses the accelerator pedal when the ACC is working, the vehicle will be taken over by the driver. The distance control function of the ACC system will not be activated.

For stationary objects, such as the end of traffic flow, toll station, etc., the ACC can respond only under special conditions which are very specific.

In some cases (high speed relative to the vehicle ahead, rapid lane change, or small safe distance, etc.), the system may not have enough time to decrease the relative speed. The driver must respond appropriately in such cases. The system cannot give an audible or visual warning in each case.

Caution

When driving into and out of curves, the object selection may be delayed or disturbed. Under these conditions, the vehicle with ACC may not brake as expected or brake too late.

When driving on roads with sharp turns, such as on a serpentine road, the vehicle ahead may be lost for a few seconds due to the limited view of the sensors, which may cause the vehicle with ACC to accelerate.

If the distance between the vehicle with ACC and the adjacent lane (or the adjacent road) is too small, the ACC may respond to the vehicle and brake.

The driver is responsible for determining and maintaining a safe following distance at all times, and should not rely on the ACC to maintain an accurate following distance.

When driving uphill or downhill, due to system limitations, there may be a certain error between the actual cruise speed of the ACC and the set cruise speed. Sufficient speed control may not be provided due to limited braking capacity and driving on a slope, and the distance to the vehicle ahead may be misjudged.

Usage restrictions

The adaptive cruise control relies on other systems, such as ESP system. If the function of any system is disabled, the adaptive cruise control system will be automatically disabled. In the case of automatic deactivation, a sound signal will be emitted and a

Starting and Driving

message will be displayed on the driver side display. The driver must intervene to match the speed and distance of the vehicle ahead. The causes of automatic disabling may be:

- The driver opened the door.
- The hood or trunk is opened.
- The driver unfastened his/her seat belt.
- The brake pedal is depressed.
- The vehicle is in a gear other than D.
- The motor speed is too low/too high.
- The tire lost its grip.
- The braking temperature is too high.
- The parking brake is used.
- ESC (Electronic Stability Control) function is activated.
- Automatic Emergency Braking (AEB) function is activated.
- ESC is turned off (i.e. when pressing the ESC OFF switch, the ESC OFF indicator on the instrument cluster illuminates, and the ESC system is turned off).
- The vehicle collides.
- The recognition capability of the camera is deteriorated under direct sunlight or oncoming strong light.
- A camera or front millimeter wave radar sensor fails.
- The vehicle speed is greater than the maximum failure speed of 130 km/h.
- The radius of road curve is less than 250 m.
- See "Camera" for camera restrictions.
- See "Radar" for radar restrictions.

ICA (Integrated Cruise Assist)

The ICA (Integrated Cruise Assist) is used to assist the driver in operating the vehicle on a structured road, and reduce the driver's fatigue due to repeated driving behavior during long-distance driving. This function can provide longitudinal and transverse auxiliary controls of the vehicle according to the traffic conditions in the driving direction; longitudinal control can achieve cruise control and car following, while transverse control enables the vehicle to be controlled near the center of lane according to the lane lines on both left and right, providing the driver with an easier driving mode.

The integrated cruise assist aims to follow the vehicle ahead and maintain the vehicle in its own lane at the following time interval set by the driver. If the camera and front millimeter wave radar sensor cannot detect any vehicle ahead, the speed set by the driver will be maintained. The above situation also occurs if the speed of the vehicle ahead exceeds the set speed. If the camera cannot see the lane lines ahead, the integrated cruise assist function will be restricted and degraded to adaptive cruise control.

Activation of integrated cruise assist

When the "ICA (Integrated Cruise Assist) indicator

(gray)"  on the instrument cluster illuminates, you can use the ICA (Integrated Cruise Assist) function, which is in standby state.

Starting and Driving

In this state, you can move the shift lever down to the bottom twice continuously and release it to activate the ICA (Integrated Cruise Assist) function.

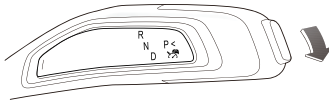

When the ICA (Integrated Cruise Assist) function is activated, the "ICA (Integrated Cruise Assist) indicator (blue)"  on the instrument cluster illuminates.

Deactivation of integrated cruise assist

To manually deactivate the cruise control, pull up the shift lever or shift the gear, and depress the brake pedal. When the cruise control is deactivated, the ICA (Integrated Cruise Assist) indicator will change from blue to gray, or the ACC (Adaptive Cruise Control) indicator will go out.

Restoration of integrated cruise assist

Recover by shifting the shift lever down to the bottom twice.

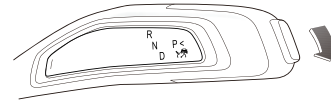

Caution

The integrated cruise assist is not a collision avoidance system. If the system does not detect the vehicle ahead, the driver must intervene. For intersections, the integrated cruise assist may correct the steering wheel, and require the driver to hold the steering wheel at the intersections and get ready to take over the vehicle at any time.

For people or animals, as well as small vehicles such as bicycles, motorcycles and electric bicycles, the integrated cruise assist will not apply the brake. This is also the case for flatbed trailers and approaching, slowly moving or stationary vehicles and objects.

The integrated cruise assist shall not be used in case of urban roads, intersections, slippery surfaces, roads with accumulated water or mud, cloudy, rainy or snowy weather, poor visibility, winding roads or highway entrances and exits. The driver assistance system is not suitable for the situation in which sunlight obliquely shines on the camera from the front of the vehicle and the case in which the high beam coming from the opposite side shines on the camera at night when entering/leaving the tunnel entrance.

Starting and Driving

Caution

The integrated cruise assist may be deactivated when the direction of lane lines ahead changes rapidly, such as lane merge, road diversion, sudden increase or decrease in lane width, please always take over the vehicle in advance.

The integrated cruise assist will occasionally assist the vehicle in steering when the steering assist is not required or when you do not intend to steer, which may be due to unclear or irregular lane lines, or other lines or objects similar to the lane lines on the lane surface. In this case, the driver should take over the vehicle immediately.

When the integrated cruise assist system detects that the driver does not hold the steering wheel, it will provide a takeover request prompt "Please turn the steering wheel slightly" through the instrument cluster, and give an audible alarm, accompanied by flashing of a white light band. At this time, the driver should hold the steering wheel immediately and take over the steering wheel if necessary to avoid danger. If the system detects that you have not taken over the vehicle for multiple times, the function will automatically exit to ensure driving safety.

If the driver ignores the alarm message for several consecutive times in a driving cycle, the ICA (Integrated Cruise Assist) function can no longer be used. The vehicle may not use the ICA (Integrated Cruise Assist) function until the next ignition cycle.

Usage restrictions

The causes of automatic disabling may be:

- The ACC function is deactivated or inhibited.
- The lane condition or lane level is not met.
- The driver turns on the turn signal.
- The driver opened the door.
- The hood or trunk is opened.
- The driver unfastened his/her seat belt.
- The brake pedal is depressed.
- The vehicle is in a gear other than D.
- The motor speed is too low/too high.
- The tire lost its grip.
- The braking temperature is too high.
- The parking brake is used.
- ESC (Electronic Stability Control) function is activated.
- Automatic Emergency Braking (AEB) function is activated.
- ESC is turned off (i.e. when pressing the ESC OFF switch, the ESC OFF indicator on the instrument cluster illuminates, and the ESC system is turned off).
- The vehicle collides.
- The recognition capability of the camera is deteriorated under direct sunlight or oncoming strong light.
- A camera or front millimeter wave radar sensor fails.
- The vehicle speed is greater than the maximum failure speed of 130 km/h.
- The radius of road curve is less than 250 m.

Starting and Driving

- See "Camera" for camera restrictions.
- See "Radar" for radar restrictions.
- The system is also inhibited under the following conditions:
 - If the vehicle ahead is braked suddenly, unexpected braking or failure to brake may occur due to the restrictions of the camera and front millimeter wave radar. If the lane lines ahead change from narrow to wide or from wide to narrow, correction of the steering wheel with large angle may occur due to camera recognition restrictions and internal algorithm logic.
 - The integrated cruise assist is mainly used when driving on flat roads with clear lane lines. When driving with heavy loads on steep downhill roads, it may be difficult for the function to maintain the correct distance from the vehicle ahead. In these cases, be careful and prepare to brake at any time.
 - When driving on roads with sharp turns, such as on a serpentine road, the integrated cruise assist function may not detect the vehicle ahead due to the limited view of the front millimeter wave radar sensor and camera, which may cause the integrated cruise assist to accelerate the vehicle, and the driver should be ready to take over the vehicle at any time.
 - If the distance between the vehicle with integrated cruise assist and the adjacent lane is too small (or the vehicle in the adjacent lane is too close to the vehicle with integrated cruise assist), the integrated cruise assist may respond to

the vehicle and brake, and the driver should pay attention to the road changes and take over the vehicle immediately.

- The performance of integrated cruise assist on a slope depends on the vehicle speed, load, and gradient. When the vehicle runs uphill, it may be required to depress the accelerator pedal to maintain the vehicle speed. When the vehicle runs downhill, it may be required to brake or shift to a low gear to maintain the vehicle speed.

Starting and Driving

RCW (Rear Collision Warning)

The RCW (Rear Collision Warning) monitors the objects behind the vehicle in real time through the rear radar, and gives an alarm when it detects that a vehicle is rapidly approaching and may collide with the rear end.

Function activation or deactivation

Function activation method

When the vehicle is started, the collision assist function is activated by default.

To reactivate the function after you deactivate it, set on the center console screen: Settings -> Advanced Driver Assistance -> Activate Collision Assist.

Function deactivation method

Set on the center console screen: Settings -> Advanced Driver Assistance -> Deactivate Collision Assist.

Information prompts

- Visual alarm
 - Text reminder: Risk of collision.
- Audible alarm: The entertainment system speaker alarms.

Caution

The rear collision warning prompt cannot replace the rear observation function of rearview mirrors.

The rear collision warning is a driver assistance function, which cannot provide assistance in all situations.

The rear collision warning does not mean that the driver may relax, but drive safely and carefully.

Usage restrictions

- The rear collision warning cannot provide accurate warnings in all scenarios, and unnecessarily missed warnings may be caused due to various reasons: for example, affected by the radar principles, large moving metal objects or complex metal walls in the blind spot, etc.
- See "Radar" for radar restrictions.

Starting and Driving

Rear collision assist

The rear collision assist function detects pedestrians behind. When the vehicle may collide with the pedestrian behind while reversing, and the driver does not take measures, the system will trigger the rear collision assist function to actively decelerate the vehicle.

When the rear collision assist is active, this is not a normal driving style for most drivers and they may feel uncomfortable. When the collision assist successfully avoids collision with the vehicle ahead, the vehicle will remain stationary for a short period of time and the driver should take actions as soon as possible.

The driver or occupant usually notices the function of collision assist only when the vehicle is about to collide. The rear collision assist is activated when the driver should start braking early, but it cannot assist the driver in all cases.

Function activation or deactivation

Function activation method

When the vehicle is started, the collision assist function is activated by default.

To reactivate the function after you deactivate it, set on the center console screen: Settings -> Advanced Driver Assistance -> Activate Collision Assist.

Function deactivation method

Set on the center console screen: Settings -> Advanced Driver Assistance -> Deactivate Collision Assist.

Information prompts

- Visual alarm
 - Text reminder: "AEB (Automatic Emergency Braking) warning light (red)"  flashes.
- Audible alarm: The entertainment system speaker alarms.

2

Caution
The rear collision assist cannot replace the rear observation function of rearview mirrors.
The rear collision assist is a driver assistance function, which cannot provide assistance in all situations.
The rear collision assist does not mean that the driver may relax, and it is the driver's responsibility to reverse in a safe manner.

Usage restrictions

- The objects mainly detected by the rear collision assist are the pedestrians behind.
- The rear collision assist cannot avoid all collision conditions due to limited detection area of the radar sensor.

Starting and Driving

- When the vehicle speed is greater than 10 km/h, the system will not work. Lower speed may indicate that you are driving on a congested road and the occasional triggering of the system may provide bad driving experience.
- The driver should ensure that the seat belt has been fastened, otherwise the rear collision assist will not work.
- Please ensure that the electronic stability control and rear collision assist function are activated, otherwise the rear collision assist function will not work.
- Certain objects will affect and impair the detection of sensors, such as road fences, tunnel entrances, heavy rain or snow, which may in turn affect the related functions of the rear collision assist.
- The detection capability of cameras will be affected by severe weathers, such as high wind, heavy rain, dense fog, etc., which will reduce the system performance or increase the false trigger rate.
- See "Radar" for radar restrictions.

SLIF (Speed Limit Information Function)

The SLIF (Speed Limit Information Function) recognizes speed signs by using the intelligent front view camera and sends relevant information to the instrument cluster to remind the driver of the speed limit information of the current road and prevent overspeed. The system does not actively adjust the vehicle speed at this time, and the driver should actively control the vehicle speed.

Function activation or deactivation

Set on the center console screen: Settings -> Advanced Driver Assistance -> Speed Limit Assist, where you can activate/deactivate the speed limit information function.

Function activation conditions

- The vehicle speed is less than 130 km/h.
- The sensor signal is normal (camera).
- A speed limit sign is detected.
- The front view camera module at the windshield is not blocked/fogged, etc.

Note: *After the function is activated, it will not work temporarily when the vehicle speed is greater than 130 km/h.*

Information prompts

If a speed limit sign is recognized when the current vehicle speed is less than the speed of the speed limit sign after the function

is activated, the instrument cluster will display the current speed limit value.

If it is detected that the current vehicle speed is greater than the speed of the speed limit sign, the speed limit sign will flash with an audible alarm.



indicates the speed limit value of the current road.

- Driving too close to the vehicle ahead, which obstructs the detection range of the camera.
- Recent changes to road or speed limit, such as construction and restrictions.
- Some LED speed limit signs.
- See "Camera" for camera restrictions.

Caution

When the system cannot recognize the information of the speed limit sign ahead, the instrument cluster will not display the speed limit sign information.

The system only displays the speed limit information, and does not control the vehicle speed.

The recognition of speed limit signs by the system is not entirely accurate, so that false recognition may occur, and the driver should drive carefully according to the actual road conditions.

Usage restrictions

The traffic sign information function works properly only when the speed signs are clearly visible. It may not work properly or may not work in some cases. For example:

- Speed limit signs in poor condition, e.g. faded, on a curve, improper angle, rotated or damaged, fully or partially blocked, too far or too high, adhering to the road surface.

Starting and Driving

ISA (Intelligent Speed Assistance)

The ISA (Intelligent Speed Assistance) recognizes the speed signs by using the intelligent front view camera when the ACC function is activated, and sends relevant information to the instrument cluster to remind the driver to decelerate. If the driver fails to decelerate immediately, the system will actively decelerate.

When the intelligent speed assistance function is active, the system will actively decelerate according to the information of the speed limit sign. If the driver requires acceleration subjectively, the vehicle speed can be controlled by depressing the accelerator pedal. When the driver releases the accelerator pedal, the system will restore the speed limit control. The system will also deactivate the speed limit control by short pressing or long pressing the RES+ button.

Function activation or deactivation

Set on the center console screen: Settings -> Advanced Driver Assistance -> Speed Limit Assist, where you can activate/deactivate the speed limit information function.

Function activation conditions

- The vehicle speed is greater than 30 km/h and less than 130 km/h.
- The sensor signal is normal (camera).
- A speed limit sign is detected.

- The front view camera module at the windshield is not blocked/fogged, etc.

Note: After the function is activated, it will not work temporarily when the vehicle speed is less than 25 km/h or greater than 130 km/h.

Information prompts

If a speed limit sign is recognized when the current vehicle speed is less than the speed of the speed limit sign after the function is activated, the instrument cluster will display the current speed

limit value .

If it is detected that the current vehicle speed is greater than the speed of the speed limit sign, the system will actively decelerate, the intelligent speed assistance function will be activated, the speed limit sign will flash, and the instrument cluster will display



Caution

When the system cannot recognize the information of the speed limit sign ahead, the instrument cluster will not display the speed limit sign information.

The recognition of speed limit signs by the system is not entirely accurate, so that false recognition may occur, and the driver should drive carefully according to the actual road conditions.

This is an auxiliary function only and cannot help the driver decelerate at any time. The driver should always pay attention to the traffic ahead and follow the traffic regulations.

Usage restrictions

The traffic sign information function works properly only when the speed signs are clearly visible. It may not work properly or may not work in some cases. For example:

- Speed limit signs in poor condition, e.g. faded, on a curve, improper angle, rotated or damaged, fully or partially blocked, too far or too high, adhering to the road surface.
- Driving too close to the vehicle ahead, which obstructs the detection range of the camera.
- Recent changes to road or speed limit, such as construction and restrictions.
- Some LED speed limit signs.
- See "Camera" for camera restrictions.

IHC (Intelligent Headlight Control)

The IHC (Intelligent Headlight Control) recognizes the traffic environment ahead through the front view camera on the vehicle, and automatically controls the switching of high and low beams to prevent dazzling the vehicle ahead and oncoming vehicles, and improve the driving safety and comfort in dark environments, especially at night.

Function activation or deactivation

Function activation method

Set on the center console screen: Exterior Lights -> Light Settings -> Activate Intelligent Headlight Control Switch.

Function deactivation method

The intelligent headlight control can be deactivated in two ways:

- Press and hold the high beam or turn signal lever switch towards the steering wheel for more than 2 seconds.

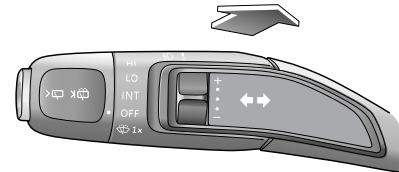

Starting and Driving

- Set on the center console screen: Exterior Lights -> Light Settings -> Deactivate Intelligent Headlight Control Switch.

Function activation conditions

- The vehicle speed is greater than 40 km/h.
- The light control switch is in AUTO position.
- The headlight low beam \equiv already illuminates.
- The front view camera module at the windshield is not blocked/fogged, etc.

Note: After the function is activated, it will not work temporarily when the vehicle speed is less than 25 km/h.

Information prompts

When the intelligent headlight control function is activated, its operation can be observed through the auto high beam indicator on the instrument cluster.

When the "IHC (Intelligent Headlight Control) indicator (blue)"



illuminates, the conditions for turning on the high beam are met currently, and the system automatically turns on the high beam.

When the "IHC (Intelligent Headlight Control) indicator (gray)"



illuminates, the conditions for turning on the high beam are not met currently, and the system automatically turns off the high beam.

When the intelligent headlight control function fails, the instrument cluster will prompt that the system is unavailable through the pop-up box "Intelligent headlight control unavailable".

Caution

The front view camera module is mounted on the windshield, which shall not be blocked, otherwise the function will be inhibited.

The perception of surrounding environment by the intelligent headlight control function is not entirely accurate, which may cause false adjustment of high beam/low beam. Please follow the local traffic regulations and use this function in a compliant and reasonable manner.

The intelligent headlight control is a comfort function only, and the driver should also drive carefully when using it.

Usage restrictions

- The intelligent headlight control function is limited by the camera status and inhibition conditions.
- If the front view camera module is not properly calibrated, the performance of intelligent headlight control will be reduced.
- If limited view is caused by dust coverage, rain, snow and fog, icing and other factors, the performance of intelligent headlight control will be reduced.
- If the surrounding light source interferes, the performance of intelligent headlight control function will be reduced.

Starting and Driving

- If a highly reflective object appears within the sensing range of front view camera module while driving, the performance of intelligent headlight control function will be reduced.
- When the ABS or ESC function is activated, the high and low beams will not be switched.
- When severe weather conditions such as sandstorm, heavy rain, and dense fog occur, the intelligent headlight control will be degraded.
- See "Camera" for camera restrictions.

Blind spot assist

The blind spot assist includes two active safety assist functions: BSD (Blind Spot Detection) and LCA (Lane Change Assist). When the subsystem detects that a vehicle is approaching at higher speed in the blind spot of rearview mirrors or from a distance, the system will warn the driver through the LED lights on the left and right exterior rearview mirrors or the sound of instrument cluster, etc.

2

Function activation or deactivation

Set on the center console screen: Settings -> Advanced Driver Assistance -> Blind Spot Assist, where you can activate/deactivate the blind spot assist function. If the switch is grayed out and cannot be operated, please drive to Our Service Dealer for service.

Detection diagram



Area ① is about 3 m behind the vehicle blind spot; area ② is about 70 m behind the vehicle blind spot.

Starting and Driving

Blind spot refers to the blind areas behind the left and right rearview mirrors of the vehicle (as shown in Area ①). If there is a vehicle in this area, this function will provide the driver with a favorable prompt to avoid the risk of collision caused by turning or lane change.

If there is a vehicle driven at high speed (much higher than that of the vehicle) as shown in Area ②, this function will provide the driver with a favorable prompt to avoid the risk of collision caused by turning or lane change.

Warning and prompt

When the vehicle is driven at a speed of more than 15 km/h, and there is a vehicle in the area ① or a vehicle is approaching quickly in the area ②, the system will actively prompt the driver, and the indicator on the corresponding side will illuminate, as shown in the figure below.

If the driver intends to change lanes or turn (turn on the turn signal on the side with a vehicle) at this time, the indicator on the corresponding side flashes with alarm tone to warn the driver.

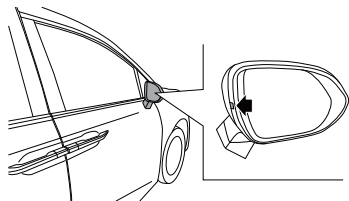

Caution

In case of sharp turns, the blind spot detection and lane change assist will not provide warning assistance.

The blind spot assist is a driver assistance function, which cannot provide assistance in all situations.

The blind spot assist is to provide better auxiliary functions in conjunction with the left and right rearview mirrors, and cannot replace the rear observation function of rearview mirrors.

If the indicator of exterior rearview mirror remains on, please drive to Our Service Dealer for service.

Usage restrictions

- The blind spot detection cannot provide accurate warnings in all scenarios, and unnecessarily missed warnings may be caused due to various reasons: for example, affected by the radar principles, large moving metal objects or complex metal walls in the blind spot, etc.
- The driver should remain vigilant while driving, always pay attention to the road conditions, and change lanes when it is safe.
- See "Radar" for radar restrictions.

RCTA (Rear Cross Traffic Alert)

The RCTA (Rear Cross Traffic Alert) is a driver assistance function, which warns the vehicles or pedestrians crossing on both left and right sides when the driver reverses the vehicle; the speed range of the rear cross traffic alert function is between 0 and 10 km/h.

Function activation or deactivation

Set on the center console screen: Settings -> Advanced Driver Assistance -> Blind Spot Assist, where you can activate/deactivate the blind spot assist function.

If the switch is grayed out and cannot be operated, please drive to Our Service Dealer for service.

Detection diagram

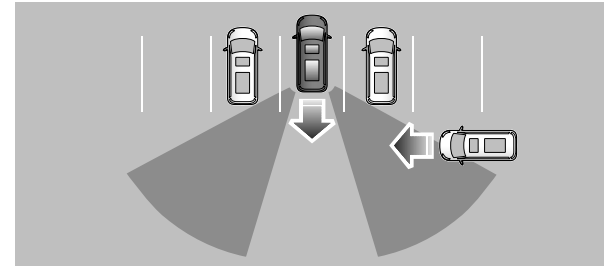
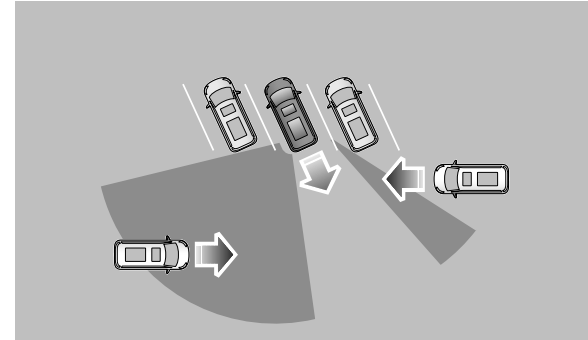
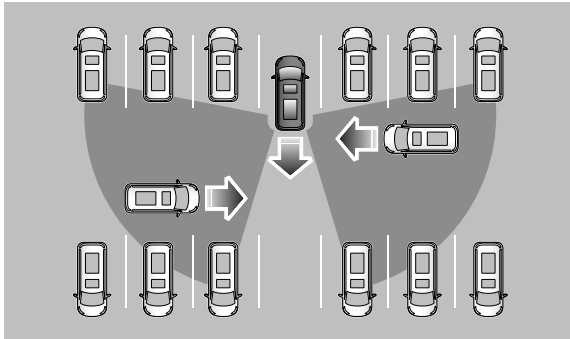

Warning and prompt

When the vehicle is in reverse mode (R gear), and there are vehicles and pedestrians crossing on both sides behind the vehicle, the indicator on the rearview mirror on the corresponding side will remind the driver by flashing, accompanied by alarm tone.

Starting and Driving

Caution

The rear cross traffic alert cannot replace the rear observation function of rearview mirrors.

The rear cross traffic alert is a driver assistance function, which cannot provide assistance in all situations.

The rear cross traffic alert does not mean that the driver may relax, and it is the driver's responsibility to reverse in a safe manner.

Usage restrictions

- The rear cross traffic alert cannot provide accurate warnings in all scenarios, and unnecessarily missed warnings may be caused due to various reasons: for example, affected by the radar principles, large moving metal objects or complex metal walls in the blind spot, etc.
- The driver should remain vigilant while reversing, always pay attention to the road conditions, and reverse when it is safe.
- See "Radar" for radar restrictions.

DOW (Door Opening Warning)

When the vehicle is stationary and in a gear other than R, the door opening warning function can detect objects such as vehicles, cyclists or pedestrians approaching from behind. If the driver or occupant opens the door when an approaching object is detected, the door opening warning will give a warning prompt, so that the driver or occupant avoids the risk of scratching with the object.

Function activation or deactivation

Set on the center console screen: Settings -> Advanced Driver Assistance -> Blind Spot Assist, where you can activate/deactivate the blind spot assist function.

If the switch is grayed out and cannot be operated, please drive to Our Service Dealer for service.

Detection diagram

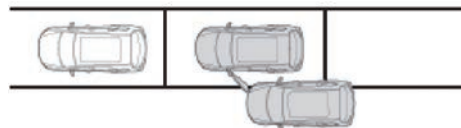

Warning and prompt

When an object is approaching the stationary vehicle, the door opening warning function will illuminate the warning indicator. In

Starting and Driving

this case, the driver or occupant should not open the door, but confirm the safety of door opening first.

If the driver or occupant opens the door on the alarm side at this time, the warning indicator will flash, while the corresponding pop-up window and alarm tone are also provided on the instrument cluster, and the door atmosphere light on the corresponding side will illuminate to remind the driver or occupant to pay attention to the safety of door opening.

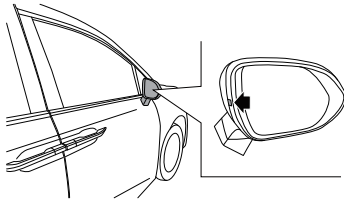

Caution

The door opening warning function is a driver assistance function, which cannot work in all situations and replace the rear observation function of rearview mirrors. The door opening warning function is limited by the principles of the sensor and complexity of traffic environment, and may give unnecessary or missed alarms. Active observation of the door opening environment before exit is the most effective measure for the driver and occupant to ensure personal safety.

Usage restrictions

- The door opening warning function is valid only when the vehicle is stationary and in a gear other than R, which will not work when the vehicle is moving.
- The door opening warning function can be activated only when the vehicle is in a gear other than R and the vehicle speed is lower than 5 km/h.
- This function can be activated only when the vehicle is stationary or its speed is lower than 3 km/h; an alarm can be triggered only when the target vehicle speed is greater than 10 km/h.
- The door opening warning cannot work in all situations, and unnecessary or missed warnings may occur due to various reasons, for example, there is a small or stationary object at the left or right rear of the vehicle; or another vehicle suddenly changes its lane to the adjacent detection area of the vehicle.

The above warnings and restrictions do not include all conditions that may interfere with Door Opening Warning (DOW). In order to avoid scratches when opening a door, the driver and occupant should check if the door opening environment is safe and suitable.

Driver status monitor system

Note: *It applies to vehicles configured with driver status monitor system. It's required to connect WI-FI for activation when using the driver status monitor system for the first time. Click  for driver status monitor of setting switch on the center console screen, to view the operation guide, conduct activation steps according to operation guide, and the driver status monitor system is enabled for normal use by default if activation is successful.*

The driver status monitor system (DMS) monitors the status of the driver and even more dangerous driving behaviors through the driver status monitor system camera, and gives the corresponding effective prompts through driver status monitor system (DMS) when these dangerous driving behaviors occur. The main monitor functions of the driver status monitor system (DMS) include obstruction monitor, fatigue monitor, distraction monitor, and abnormal behavior monitor.

Driver status monitor system camera

The camera used by the driver status monitor system (DMS) is an IR imaging camera facing the driver located in the A pillar on the driver side. A series of face and body-related algorithms are built in the camera, which can monitor and judge the driver's behaviors while driving, and synchronize the monitored results with the instrument cluster timely to provide timely and effective prompts to the driver through the instrument cluster and center console screen. The camera does not record the effective

face information of the driver, only monitors different behaviors through the characteristics of the face and body actions, and immediately deletes the face information after monitoring.

Driver status monitor system control switch

The driver status monitor system consists of a master switch and four sub-switches, each sub-switch corresponds to a sub-function, and the master switch can control the status of all switches at the same time. The driver status monitor system can be turned on or off through the control buttons on the center console screen.

- The master switch of driver status monitor system is: Driver status monitor on the center console screen.
- Four sub-switches of driver status monitor system are respectively: smoke monitor, phone call monitor, fatigue monitor, distraction monitor on the center console screen.

When each switch is switched from OFF to ON, the corresponding function is activated immediately; when it is switched from ON to OFF, a window will pop up for confirmation before activation.

Driver status monitor Master switch / fatigue monitor
Sub-switch / distraction monitor Sub-switch / smoke monitor
Sub-switch / phone call monitor
When a sub-switch is turned off, the pop-up window displays: whether this function is turned off, and after it is turned off, is it unable to use the driver status monitor system/recognize the fatigue status/recognize the distraction status/recognize the smoke behavior/recognize the phone call behavior?

When the master switch and four sub-switches of driver fatigue monitor system are all turned off, the power supply of camera will be cut off, to protect the privacy of users.

Monitor functions of driver status monitor system

Obstruction monitor

When the driver places an obstruction in front of his/her face or the camera, the face recognition function of the DMS camera will be affected. At this time, the DMS function will remind the driver that the DMS function cannot be executed normally, please remove the obstruction. In this case, the driver can clear the relevant prompts by removing the obstruction.

In addition, this function classifies the obstruction into "Face Obstruction" and "Camera Obstruction". Please check different positions according to the monitored situation.

Note: This function operates when the vehicle speed is not less than 5 km/h, and gives a voice reminder and a pop-up reminder on the instrument cluster when activated.

Fatigue monitor

When the driver shows certain fatigue, the DMS camera will estimate the driver's degree of fatigue through common fatigue behaviors such as yawning and closing eyes, and conclude the driver's degree of fatigue through the estimation results. If the degree of fatigue exceeds a certain standard, the DMS camera will remind the driver through voice and instrument cluster.

In addition, this function differentiates between mild, moderate and severe fatigue. Under mild fatigue, the system will give voice and visual reminders; under moderate fatigue, in addition to voice and visual reminders, the center console screen will recommend to enable relevant driver assistance functions, and the driver can click "confirm" on the center console screen to enable relevant driver assistance functions; under severe fatigue, in addition to the basic voice and visual reminders, the center console screen will recommend to be associated with air conditioner for cooling, face blowing and other auxiliary measures to relieve fatigue.

Note: This function operates when the vehicle speed is not less than 30 km/h, and gives a voice reminder and a pop-up reminder on the instrument cluster when activated.

Distraction monitor

When the driver looks around during normal driving, the DMS camera will evaluate the driver's overall focus direction through the rotation angle and time of the driver's head and eyes, and determine if the driver is distracted. It should be noted that due to the time evaluation, observing the rearview mirrors and on-board mainframe for a short time will not trigger the distraction monitor.

In addition, if the body camera should be recalled to project the scene in the on-board mainframe, such as when reversing, this function will be temporarily deactivated to avoid misjudgment and other conditions.

Starting and Driving

Note: *This function operates when the vehicle speed is not less than 30 km/h, and gives a voice reminder and a pop-up reminder on the instrument cluster when activated. When the turn signal, reverse light, or 360° camera operates, this function will not be activated.*

Abnormal behavior monitor

When the driver is smoking, calling, etc., the DMS camera will judge if the driver has improper driving behaviors currently such as smoking or calling while driving by monitoring the item in the driver's hand and its corresponding position. If the corresponding behavior is monitored, the system will give a voice reminder and a pop-up reminder on the instrument cluster to try to stop the driver's improper driving behavior, which plays a corrective role. In addition, when the driver triggers the smoke behavior monitor, the system will recommend to open window or turn on air conditioner to purify the interior air.

Note: *This function operates when the vehicle speed is not less than 30 km/h, and gives a voice reminder and a pop-up reminder on the instrument cluster when activated.*

Tires



DEFECTIVE TIRES ARE DANGEROUS!

Do NOT drive your vehicle if any tire is excessively worn, damaged or inflated to an incorrect pressure.

Do NOT overload vehicle.

Incorrect tire inflation pressures or an unbalanced wheel and tire assembly can seriously affect the stability, especially when driving with high payloads or at high speeds. Under-inflation will increase rolling resistance and accelerate tire wear, resulting in tire damage, even an accident.

Always drive with consideration for the condition of the tires; the most common causes of tire failure are:

- Bumping against curbs.
- Driving over deep pot holes.
- Tire under-inflation or pressure overload during driving.

Uneven tread wear can be caused by faulty wheel alignment.

Starting and Driving

Winter tires



The vehicle speed shall not exceed the maximum allowable speed of the installed winter tires, otherwise the tires may suddenly lose pressure, delaminate, or even burst, which may easily cause accidents!

Be sure to adjust the speed according to the specific climate, roads and traffic conditions. Do not take risks by taking advantage of the anti-skid performance provided by winter tires and beware accidents!

Winter tires can improve the handling stability and braking performance of the vehicle when driving in a low temperature environment or on icy roads. It is suggested that winter tires should be used when the temperature is lower than 7°C.

When a vehicle is running under winter road conditions, winter tires can greatly improve the handling stability and braking performance. Non-winter tires have poor skid resistance at low temperatures or on icy roads due to their structure (tire width, rubber composition, pattern type, etc.).

It is recommended to use winter tires of the same size and load index as that of the original tires, and all the four wheels shall use winter tires.

When the tread depth of winter tires is worn to 4mm, the skid resistance will decrease obviously.

The maximum allowable speed of winter tires shall be subject to the speed code on the tires.

Speed symbol	Maximum speed (km/h)
C	60
D	65
E	70
F	80
G	90
J	100
K	110
L	120
M	130
N	140
P	150
Q	160
R	170
S	180
T	190
H	210
V	240
W	270
Y	300

Starting and Driving

In addition, it is recommended to set the overspeed alarm, which can be controlled to turn on or off via the touch button on the center console screen.

When the temperature rises above 7°C, it is recommended to replace winter tires with non-winter tires.

Anti-skid chain

When driving a vehicle in the snow, it is recommended to apply S anti-skid chain to the driving wheels.

The anti-skid chain could increase the traction when driving on roads in winter. If you want to install the anti-skid chain, please remember that:

- 1 Not all wheels and tires are suitable for an anti-skid chain. When installing anti-skid chains, only approved tire size can be used.
- 2 Only apply anti-skid chain to two driving wheels. Please follow the instructions of anti-skid chain manufacturer.

It is just in the snow that you can drive the vehicle at maximum speed allowed by the anti-skid chain. Please comply with the regulatory requirements of the resident country. Remove the anti-skid chain immediately when driving on the snow-free road.

Loading

Each driver is obliged to ensure his vehicle is free of overload.

Note: The maximum allowable total mass is indicated on the VIN Plate located at front lower of B pillar. This handbook introduces the correct vehicle weight parameters, see "Vehicle weight parameters".

Note: Secure all loads in the vehicle to prevent personal injury due to movement of loads. The driver is obliged to ensure all goods have been fixed correctly.

There is a legal requirement to display a specific type of external warning sign on the vehicle if certain hazardous goods are being carried.

Trailer towing

Note: *It applies to vehicles configured with trailer towing.*

Instructions of trailer towing

The vehicles are designed for use primarily as a passenger and load bearing vehicle. Towing a trailer may create adverse effects on a number of factors including handling, durability, performance and braking. We recommend for the safety of yourself, your passengers and others that the vehicle and trailer is not overloaded.

The warranty does not cover any damages caused by or relating to towing a trailer.

- Weight limits

Establish that gross vehicle weight, trailer tow ball down load, trailer weight and axle weights are all in accordance and not exceeding their individual limits.

- Gross vehicle weight

Please refer to your vehicles data label for reference on what gross vehicle weight must not be exceeded.

Gross vehicle weight is the combined weight total of the trailer towbar, unloaded vehicle, driver, luggage and passengers. This also includes the weight of any accessories or equipment added to the vehicle.

Instructions before use

- The state specific trailer towing regulations must be followed.
- The vehicle speed should not exceed 120 km/h.
- It is only applicable to center axle trailers, and the load specified in "Recommended towing weight" shall not be exceeded when towing trailers.
- When a new vehicle has been driven or a vehicle has had powertrain parts changed to new parts, it is recommended not to tow a trailer until the driving distance reaches 800 km.
- Place the load as close as possible to the trailer axle, fix it securely and place it as low as possible, while ensuring that the towing weight and the load allowed by the tow ball are not exceeded (Refer to "Recommended towing weight" for details). For best stability of the trailer in an unladen vehicle, place the load in the trailer towards the nose within the maximum nose load (Refer to "Recommended towing weight" for details), as this gives the best stability.
- The specified trailer loads are only applicable to an altitude less than 1,000 m. As the air density decreases with the altitude increase, causing the drive motor output and grade ability to drop, the total mass must be reduced by 10% when the altitude increases by 1,000 m.
- The tires of towing vehicle shall be adjusted to the specified pressure, and the pressure of trailer tires shall also be checked, and on the rear tire pressure, at least 20kPa(0.2bar) above the tire pressure as recommended for normal use (i.e. without a trailer attached).

Starting and Driving

- If the traffic conditions behind the trailer are invisible through the standard outside rear view mirrors, two additional rear view mirrors must be installed on the reversible boom and adjusted to ensure sufficient rear view at any time.
- The headlamps shall be checked and adjusted if necessary after a trailer is hitched up.
- Always use a safety chain that is suitable for your vehicle and trailer. Have the safety chain passing through the hole at the lower part of the hitch and attach it to the trailer. The safety chain will prevent the trailer from dropping to the ground in the event that the hitch disengages. For proper use and installation, consult the trailer manufacturer.

Instructions for driving

- Before driving, check all the safety equipment to ensure safe operation. Ensure that the vehicle is properly maintained to avoid mechanical failure.
- Avoid non-loaded towing vehicle and loaded trailer as much as possible when driving. If it is inevitable, drive at low speed due to improper load distribution.
- As the driving stability of towing vehicle and trailer drops with the speed increase, the speed shall be as low as possible without exceeding the specified speed limit under the improper road, weather and strong wind conditions, especially when driving on a slope.
- When the trailer sways, grip the steering wheel firmly to drive straightforward, and release the accelerator pedal to decelerate the vehicle slowly. Do not attempt to eliminate sway by turning the steering wheel or by emergency braking. The higher the speed, the stronger the trailer swaying. If the sway is still not eliminated after deceleration, stop the vehicle to check if the trailer weight distribution is even and the trailer device is installed securely.
- Under any conditions, the vehicle must be decelerated immediately once minor sway is noticed on the trailer, and never try to eliminate the sway through acceleration.
- If an inertia brake is installed on the trailer, first brake slowly and then brake rapidly when braking is required. This can avoid braking impact due to trailer wheel locking.
- Clean, dry and flat concrete or asphalt (or similar) pavement is required for towing.

Starting and Driving

Recommended towing weight

Towing capacity

GVW(kg)	CVW(kg)	ATM(kg)-braked trailer	ATM(kg)-unbraked trailer	GTM(kg)
3000	2310	1000	750	3420
3095	2410	1000	750	3520
3095	2535	1000	750	3645

Caution

The sum of the total mass of the towing vehicle and the total mass of the trailer shall not exceed the specified gross train mass (GTM) of the vehicle.

2

Starting and Driving

Trailer electrical interface

For models with optional trailer electrical interface, the harness is the trailer electrical interface, which can be connected to the trailer module, at the lower part of the left rear bumper of the vehicle and viewed from the bottom of the vehicle.

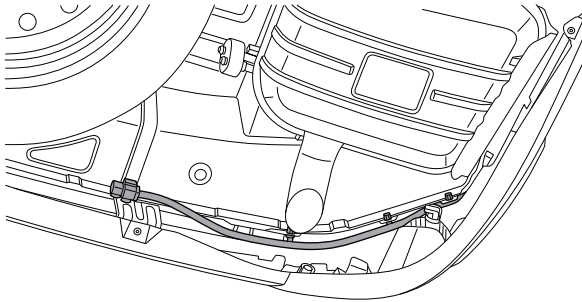

Maintenance

If the vehicle is often used to tow a trailer, additional maintenance shall be made in the maintenance intervals to ensure continuous satisfaction for the vehicle.

Emergency Troubleshooting

212 Emergency Door Opening or Closing

214 Hazard warning light

214 Warning triangle

215 Self tire repair

221 Towing a vehicle

224 Jump start

226 Fuse replacement

Emergency Troubleshooting

Emergency Door Opening or Closing

Manually unlock and lock the driver door

When the vehicle is powered off or the doors can not be unlocked or locked electronically, the driver door can be unlocked and locked manually.

- 1 Insert the key into the opening of the cover from below.

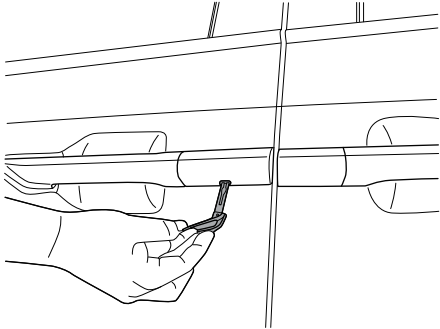

- 2 Turn the key to release the cover and remove it.
- 3 With the key, manually lock and unlock the driver door through the door lock on the driver door.

Caution

After unlocking and locking is completed, it is required to pull the exterior door handle first before mounting the cover.

Manually lock the front occupant door and rear doors

When the vehicle is powered off or the doors can not be locked electronically, the front occupant door and rear doors can be locked manually.

Use the key to turn the lever at the position shown counterclockwise, and then close the door to lock it.

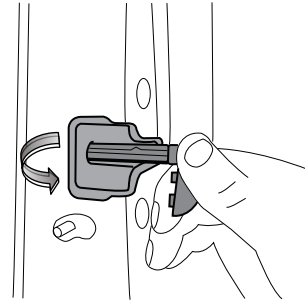

To open the front occupant door and rear doors, pull the interior door handle twice to open the door.

Emergency Troubleshooting

Manually unlock the tailgate

When the vehicle is powered off or the tailgate can not be unlocked electronically, the tailgate can be unlocked manually.

Open the cover at the lower end of the tailgate inner trim panel and press down the white lever to open the tailgate.

Manual tailgate

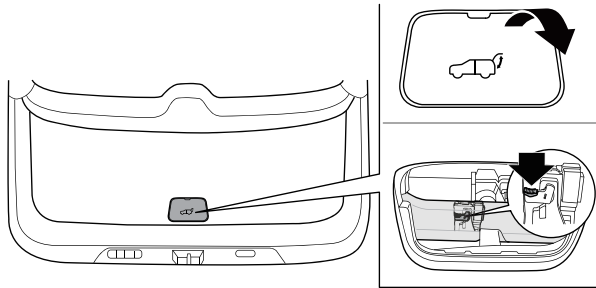

Power tailgate

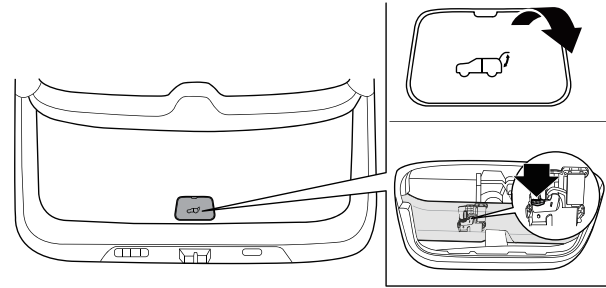

3

To close the tailgate, lower the tailgate and press it down firmly to make sure that the tailgate is locked securely.

Emergency Troubleshooting

Hazard warning light

When you encounter a problem during driving and have to stop the vehicle or slow down, you shall press the hazard warning light switch  on the front roof vanity light, the "direction indicator (green)" on the instrument cluster will illuminate and flash, meanwhile all the turn signals flash to alert others and make the police know you are in trouble.

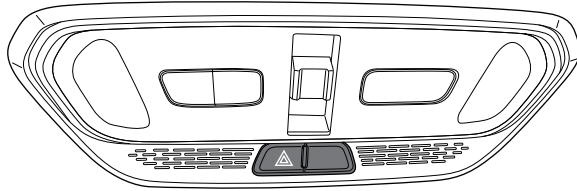

Warning triangle

The warning triangle is placed in the front compartment storage box.

When you encounter a problem during driving and you have to pull the vehicle over, if the situation permits, on the conventional road, please place a warning triangle about 50 - 150m right behind the vehicle to alert vehicles behind; On highways, a warning triangle should be placed about 150m right behind the vehicle; in rainy and foggy day with low visibility, place the warning triangle about 200m right behind the vehicle, to alert vehicles behind.

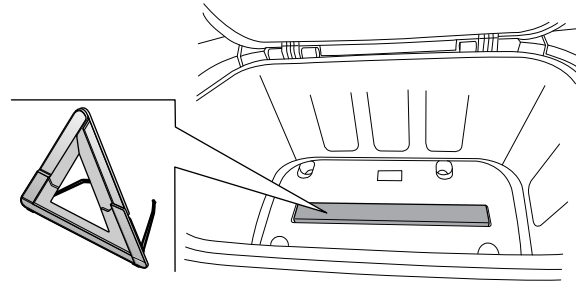

Emergency Troubleshooting

Self tire repair

Note: *It applies to vehicles configured with tire repair kit.*

Precautions

 **The main components of the tire cement product are natural emulsions, which are inedible, so avoid inhalation or swallowing of them. If ingested by accident, go to the hospital immediately, and do not induce vomiting.**

Avoid human skin or eyes from contacting with this tire cement, otherwise skin or eyes discomfort may occur. If this tire cement contacts with skin by accident, rinse the skin thoroughly with water and soap; if this tire cement accidentally gets into the eyes, please rinse the eyes with water immediately. Keep this product out of the reach of children.

During the use of this product, please obey the road traffic safety laws and other regulations.

- Read the Instructions carefully before using this tire cement.
- After using this product to repair a flat tire, the driving speed shall be maintained within 80 km/h.
- When using this product to repair a flat tire, due to the pressure of the flat tire, it may lead to some tire cement leakage at the connection between the glue tube and the tire, which is a normal phenomenon.

- This product adopts natural emulsion, which is same with the raw material of the tire, has no damage to tires and wheel hubs, and can be used within the ambient temperature range of -40°C ~ 80°C.
- Please go to Our Service Dealer for inspection and repair as soon as possible after the driving is over.

Tire repair kit

The tire repair kits are placed in the front compartment storage box.

Caution

For vehicles with 19-inch self-repair tires, when the puncture width is less than 5 millimeter, the vehicle can still continue to drive within a certain speed range (120km/h) if the display shows that the tire pressure is normal. However, the self-repair tires cannot be regarded as permanent repairing measures; if it is found a tire is punctured or seriously damaged, please contact Our Service Dealer in time for tire check and replacement.

3

Emergency Troubleshooting

Tire inflator pump

- Upper surface of pump body

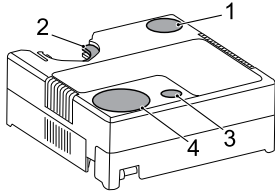

- 1 Power switch (black)
- 2 Glue pot bayonet
- 3 Relief valve switch
- 4 Air pressure gauge

- Bottom surface of pump body

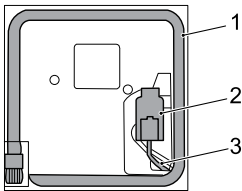

- 1 Inflation tube

- 2 Power connector

- 3 Power cord

Tire repair glue pot

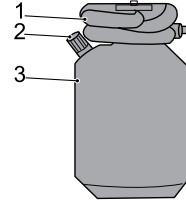

- 1 Glue tube

- 2 Inflation tube connector

- 3 Pot body

Emergency Troubleshooting

Usage

Tire repair kit has the functions of flat tire repair, tire pressure monitoring, tire inflation and deflation, etc.

Before using this product, please complete the following preparations:

- 1 Please park the vehicle in a safe place;
- 2 If a tire is flat in the course of driving, warning signs shall be set in a safe place to avoid accidents;
- 3 Identify the flat tire and determine the cause, and then complete the tire inflation or repair according to the methods for tire inflation or repair in the Instructions;
- 4 Please confirm that the tire repair glue pot and pump body are products of our company, otherwise air leakage, glue spray, adverse conditions and even dangerous consequences may occur. Please confirm that all components of product are intact before using this product;
- 5 When using this product to repair the flat tire, please check whether the glue pot is filled with glue solution.

Methods for tire repair

- 1 Make sure that the switch is off at this time. Loosen the glue tube on the tire repair glue pot, align and horizontally push the glue pot interface to the glue pot bayonet on the pump body, and then connect the inflation tube to the glue pot after installation is completed.

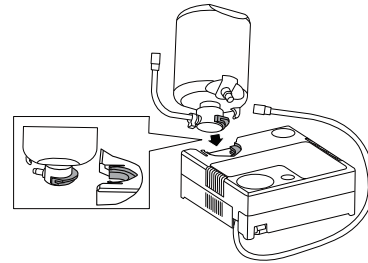

- 2 Connect the glue tube to the flat tire.

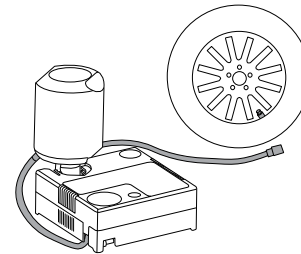

Emergency Troubleshooting

- 3 Insert the inflator pump power connector into the on-board power socket, and start the vehicle.

Note: Do not use 12V power socket located at right body side of trunk.

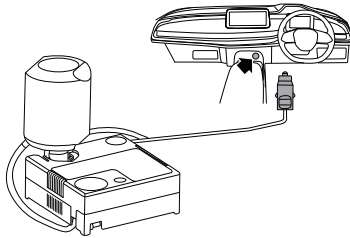

- 4 Turn on the power switch (black), start injecting the glue solution into the tire, at this time, the value on the pressure gauge will first rise and then slowly reduce to the flat tire pressure; turn off the power switch after the tire pressure reaches the recommended value (please see "Wheel and tire" in General Technical Parameters section), and then pull out the glue tube, inflation tube and power connector in sequence.

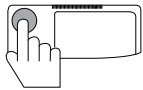

- 5 Restart the vehicle to make it drive at the speed of less than 30 km/h for 3-5 km.

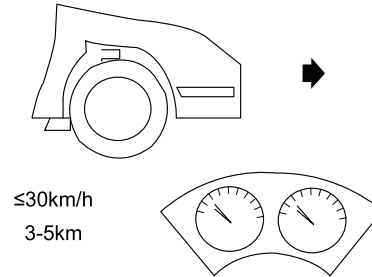

- 6 Park the vehicle in a safe place, and connect the inflation tube to the tire again.

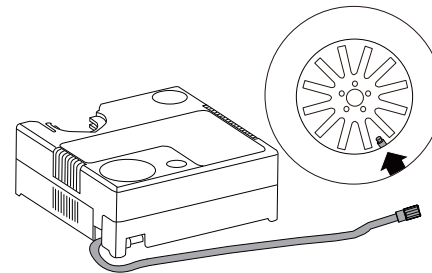

Emergency Troubleshooting

- 7 Observe the air pressure value, and perform the inflation operation if there is obvious pressure decrease. And check the tire pressure after driving for another 3-5 km (if there is still obvious pressure decrease, it indicates that the tire has been badly damaged beyond the usage range of this product, please call for rescue).

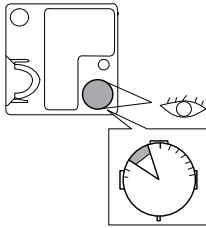

- 8 Remove the sticker with "80" character attached to the glue pot, and paste it onto the steering wheel, to remind the driver that the driving speed shall be maintained within 80 km/h after using this product.

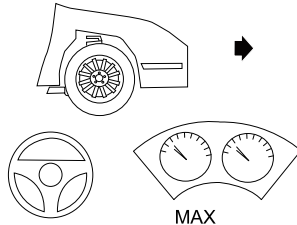

Methods for tire pressure monitoring

- 1 Remove the inflation tube and connect it to the tire.

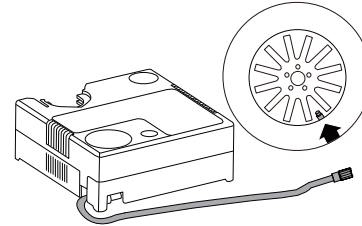

- 2 Insert the inflator pump power connector into the on-board power socket, and start the vehicle.

Note: Do not use 12V power socket located at right body side of trunk.

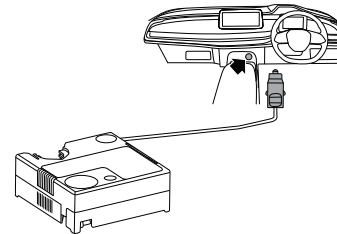

- 3 Turn on the power switch (black), pump up the tire, and observe the air pressure gauge; turn off the power switch after the tire pressure reaches the recommended

3

Emergency Troubleshooting

value (please see "Wheel and tire" in General Technical Parameters section), and then pull out the inflation tube and power connector.

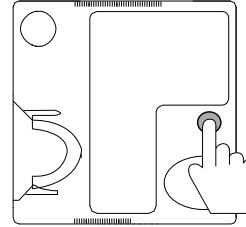
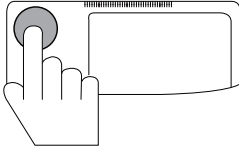

Methods for tire pressure relief

- 1 Remove the inflation tube and connect it to the tire.

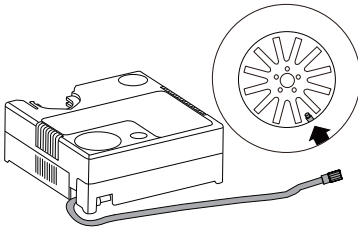

- 2 Press the relief valve switch (black), and observe the air pressure gauge until the tire pressure reduces to the desired value.

Note: After tire repair with this product, go to Our Service Dealer for tire repair as soon as possible; when professional tire repair is performed, due to residual glue solution in the tire, it is recommended to place the tire horizontally on the level ground to discharge the liquid, and it's better to put a small rag at the tire valve core, to prevent a small amount of glue from splashing out. If the tire cement accidentally drops on the floor or other objects, just wipe it off with a rag, and rinse with water. This tire cement is natural emulsion, which will cause no corrosion or other adverse effects wheel hubs and tires.

Emergency Troubleshooting

Caution

- To repair one tire, it is required to use one bottle of this tire cement product.
- To guarantee the effects in use of this product, it is better not to remove the thorn on the tire; if it is removed, the effects in use will not be influenced.
- Please do not pull out the glue tube directly from the tire during the use of this product; first turn off this product switch after the tire repair is completed, and remove the glue tube from the tire.
- When providing power for this product by starting the vehicle, apply the parking brake in advance, to avoid personal and property damages caused by vehicle movement.
- Store this product in a cool and dry place, keep it away from the fire, and try to place it in the vehicle, to better guarantee the quality of the tire cement.
- There is no side effect on the tire after using this product.
- During the use of this product, due to the compressed air, the inflation tube may become hot, which is a normal phenomenon.

Towing a vehicle

While towing or being towed, relative national regulations about vehicle towing shall be abided by.

Towing hitch

Front towing hitch

If this vehicle is to be towed from the front, first pry off the towing hitch cover from the lower part of the front grille, and screw the towing hitch placed in the vehicle tools to the front bumper.

After the vehicle towing is completed, unscrew the towing hitch and put it back in its original position, and then close the towing hitch cover.

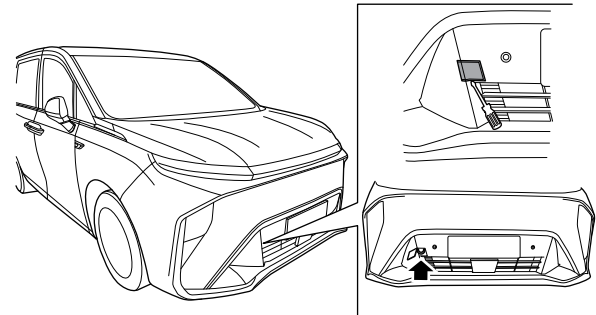

Emergency Troubleshooting

Rear towing hitch

Note: *It applies to vehicles configured with rear towing hitch.*

If the vehicle is to be towed from the rear, first pry off the towing hitch cover from the left side of the rear bumper, and screw the towing hitch placed in the vehicle tools to the rear bumper.

After the vehicle towing is completed, unscrew the towing hitch and put it back in its original position, and then close the towing hitch cover.

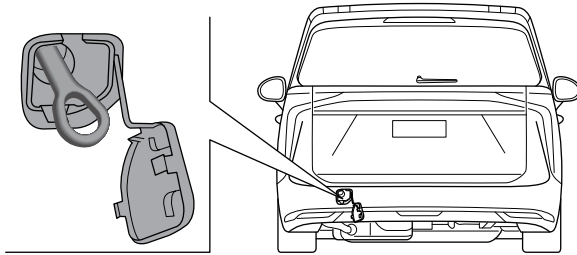

The application range of towing rope is as shown below:

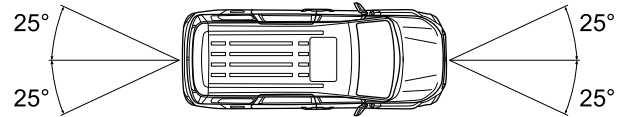

Caution

The maximum weight that the towing hitch can bear is the GVW. Do not tow a vehicle with a weight more than this value.

Emergency Troubleshooting

Towing

Before towed

! To ensure the steering gear can rotate freely, be sure to power on the vehicle and keep it powered on during towing process. This is to ensure the steering is unlocked, and the turn signal lamps and brake lamps can operate.

Being towed

When the vehicle is being towed, release the parking brake and engage N gear.

! There is no brake booster assist or power steering assist when the motor is not running. In this case, it requires greater effort to operate the brake pedal, and longer time and greater effort to rotate the steering wheel.

Caution

When towing a vehicle, be sure to lift its drive wheels off the ground, with the towing speed lower than 30km/h, the towing distance less than 50km, and the shift lever in N gear.

! After a severe collision, if you find it impossible to move the shift lever into N, shift from P to another gear, or turn the steering wheel, please note that the drive wheels must not be on the ground when towing. Failure to do so may lead to severe damage to the transmission and high service costs. It is recommended to tow the vehicle with a flatbed trailer. When towing, all four wheels must be off the ground.

Recommended vehicle towing

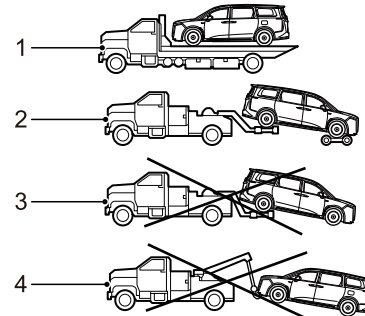

- 1 Place the vehicle on a flatbed trailer - recommended.
- 2 Lift the rear wheels, and place the front wheels on a small trailer (off the ground) - recommended.
- 3 Towing with the front wheels rolling backwards - wrong.

Emergency Troubleshooting

4 Lift the body/chassis instead of the wheels - wrong.

It is recommended to tow the vehicle with a flatbed trailer. When towing, all four wheels must be off the ground.

! When the vehicle is pulled onto the flatbed trailer, it is prohibited to have any person or object behind the trailer, as this may lead to personal injury or death. When towing the vehicle with the front wheels lifted or on a flatbed trailer, passengers are not allowed to stay in the vehicle, otherwise an accident may occur and lead to personal injury or death.

Jump start

Battery disconnection

! Always wear protective gloves and eye protecting glasses when working on a battery.

Do not use naked light, cause sparks or smoke in the area of the battery. You can be seriously injured and the vehicle damaged.

To disconnect battery, disconnect negative (-) earth terminal first and then positive (+). To connect battery, install and secure positive cable (+) first and then negative (-) cable. Smear the terminals with petroleum jelly.

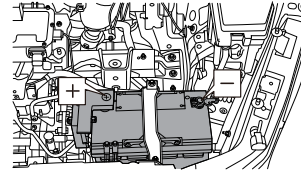

Caution

Before disconnecting the battery, always shut down the motor and all electrical devices for more than 2 minutes. While disconnecting, never allow the terminal to contact with the metal parts of vehicle body. Otherwise short circuit may cause electric spark. Electrical system will be damaged if positive and negative cables are connected reversely.

Emergency Troubleshooting

Jump start



Never pull or tow the vehicle to start.

Ensure the rated voltage of two batteries is the same (12 V) and the jumper cable is acknowledged as the cable used for 12V vehicle battery.

Jumper

- Pull two vehicles together as possible.
- Shut down the motor and all electric equipment.
- Connect the positive terminals (+) of two batteries with red jumper cable.
- Connect black jumper cable from power supplying battery negative terminal (-) to earth point (not negative terminal) of the battery-powered vehicle that needs to be powered.
- Ensure all connection mechanisms are well connected.
- Check that the jumper cable clear of any moving parts when the motor starting.
- Check that the handbrakes of the two vehicles are applied and gear lever is in P position.

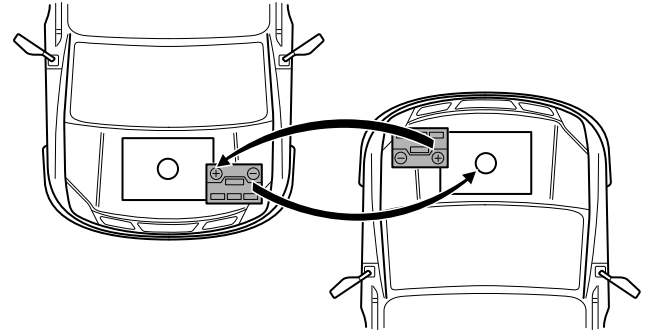

3

Starting

Start the battery-powered vehicle to be powered and allow it to idle for several minutes.

- Start the vehicle whose battery needs to be powered.
- Allow the vehicle to idle for more than 2 minutes after started.

Note: *If it fails to start after several attempts, the vehicle may need maintenance.*

Disconnecting

- Shut down the engine or motor of the vehicle.
- Ensure the cable terminals shall not contact with each other.
- Remove the jumper cable. Removal is the reverse of connection.

Emergency Troubleshooting

Fuse replacement

Fuses of this vehicle are located in three boxes.

Caution

Spillage of liquid to any electric components in the vehicle may damage the components, so it is required to cover any electric components. The content of the fuse specification list will be constantly updated according to the vehicle configuration and technical status, please see actual state of your vehicle. The corresponding components are provided only when the actual vehicle is configured with the functions. Otherwise, the components are not provided.

Driver compartment fuse box

Driver compartment fuse box is located behind the lower storage box at driver side.

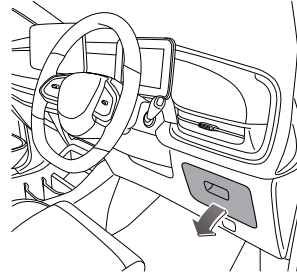

Emergency Troubleshooting

Fuses in the driver compartment fuse box can be identified by the label on the back of lower storage box cover at driver side.

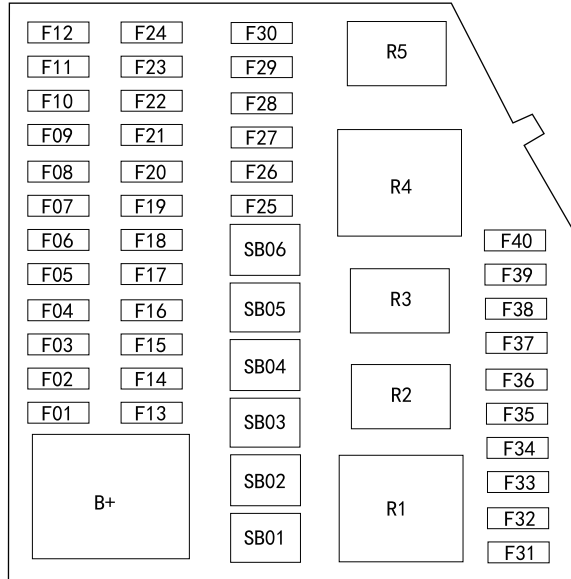

Specification

Code	Specification	Function
F01	10A	A/C control module / ETC / driver monitoring camera / rear A/C panel / traveling data recorder
F02	7.5A	Combined switch - Electronic shift lever

Code	Specification	Function
F03	7.5A	Automatic anti-dazzle interior rearview mirrors / stream media rearview mirrors
F04	7.5A	HUD (Head-up Display) / instrument cluster
F05	10A	ICGM (intelligent gateway)
F06	7.5A	Front high voltage PTC
F07	10A	ADU (driving domain control unit) / ADC (camera) / ADAS (driver assistance system)
F08	15A	Steering wheel heating KL15 power
F09	7.5A	PM2.5 / ambient light sensor / roof vanity light / roof atmosphere light / sunvisor light
F10	7.5A	Central control switch / steering wheel / electric concealed outlet / driver (front passenger) flagship and luxury headrest accessory / driver (front passenger) flagship and luxury front passenger heating pad and headrest accessory
F11	7.5A	HUD (Head-up Display)
F12	10A	Single 12.3-inch display / front passenger entertainment screen / front passenger small screen
F13	25A	Entertainment mainframe power supply
F14	30A	Third-row left high-end seat
F15	30A	Third-row right high-end seat
F16	10A	Rear A/C panel / A/C control module

Emergency Troubleshooting

Code	Specification	Function
F17	10A	IBDU (intelligent body domain controller module) (exterior lamp) KL30 power 2
F18	7.5A	Combined switch - right shift lever
F19	20A	220V inverter
F20	10A	ICGM (intelligent gateway)
F21	10A	OBD commissioning / diagnosis / calibration
F22	10A	Light & rain sensor
F23	7.5A	ADAS/ADC/AVM
F24	10A	Instrument cluster
F25	25A	Power amplifier
F26	30A	Front passenger flagship and luxury memory module, and massage and lumbar support
F27	10A	BMS
F28	7.5A	ADU (driving domain control unit)
F29	10A	Integrated tri-screen
F30	30A	third-row right high-end / low-end VIP seat
F31	/	Reserved
F32	/	Reserved
F33	/	Reserved
F34	/	Reserved
F35	/	Reserved

Code	Specification	Function
F36	20A	Front sunroof
F37	10A	Transportation mode relay
F38	/	Reserved
F39	/	Reserved
F40	10A	Power rearview mirror heating power
SB01	40A	Front blower motor
SB02	40A	Rear windshield / power rearview mirror heating power
SB03	30A	Front passenger power window regulator power
SB04	30A	Rear blower relay / rear blower power
SB05	30A	PTC1
SB06	30A	PTC2
R1	40A	Front Blower Relay
R2	35A	PTC1 Relay
R3	35A	Rear Blower Relay
R4	40A	Defrost Relay
R5	35A	PTC2 Relay

Emergency Troubleshooting

Front compartment fuse box

Front compartment fuse box is located at the right of compartment wall at the front hood bottom (viewed from the front of vehicle). Fuse can be accessed by just removing the cover of front compartment fuse box.

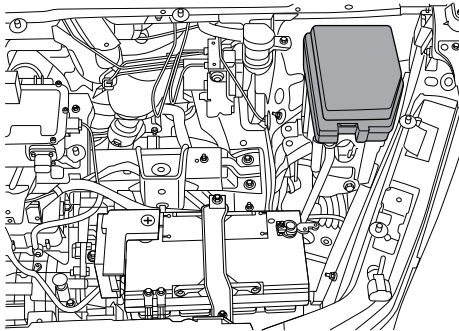

Caution

Before opening the fuse box cover, make sure its surroundings are dry and no fluid flows from any direction into the opened fuse box, otherwise the fuse box will be damaged, leading to serious consequences.

Fuses in the front compartment fuse box can be identified by the label printed at the back of the fuse box cover.

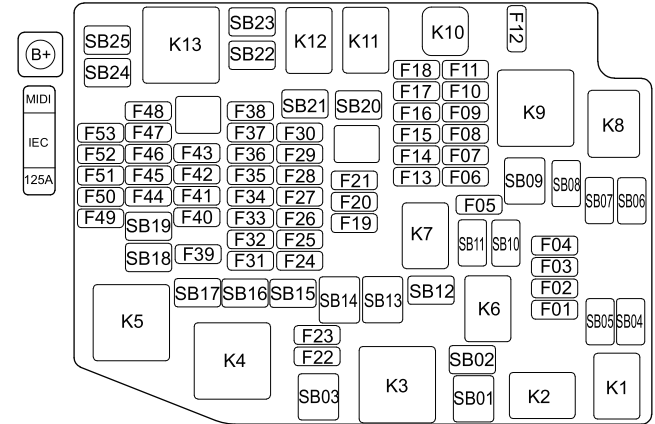

3

Specification

Code	Specification	Function
SB01	/	Reserved
SB02	30A	Front wiper
SB03	/	Reserved
SB04	30A	Rear sunroof
SB05	30A	Front sunroof / electric tailgate ECU KL30 transportation mode power
SB06	/	Reserved

Emergency Troubleshooting

Code	Specification	Function
SB07	/	Reserved
SB08	30A	Right electric power side load door KL30
SB09	40A	Trailer ECU
SB10	30A	Power driver seat KL30
SB11	/	Reserved
SB12	/	Reserved
SB13	60A	IBOOST (electric vacuum booster) KL30
SB14	60A	ESC motor KL30
SB15	25A	Trailer
SB16	30A	IEC (driver compartment fuse box) KL15
SB17	30A	Left electric power side load door KL30
SB18	30A	IEC (driver compartment fuse box) KL30
SB19	30A	Second-row left power seat KL30
SB20	/	Reserved
SB21	30A	Left window regulator
SB22	/	Reserved
SB23	30A	Power tailgate ECU KL30
SB24	40A	ESC solenoid valve KL30
SB25	/	Reserved
F01	20A	Reserved

Code	Specification	Function
F02	15A	IBDU (intelligent body domain controller module) (washer motor) KL30
F03	3A	UEC (front compartment fuse box) GND 3
F04	10A	IBDU (fuel tank cap lock) KL30
F05	15A	Horn
F06	/	Reserved
F07	10A	Intelligent grille / cooling fan KL87
F08	/	Reserved
F09	/	Reserved
F10	/	Reserved
F11	/	Reserved
F12	/	Reserved
F13	/	Reserved
F14	20A	BMS electronic water pump
F15	/	Reserved
F16	20A	Ignition coil/cooling water pump
F17	/	Reserved
F18	/	Reserved
F19	20A	IBDU (exterior lamp) KL30 power 1
F20	10A	Airbag module KL30
F21	10A	EMS (engine control module) KL30

Emergency Troubleshooting

Code	Specification	Function
F22	25A	IBDU (door lock)
F23	25A	Nets-within-nets ECU KL30
F24	25A	Second-row power seat KL15
F25	10A	EMS (engine control module) / IMCU (motor and vehicle control unit) KL15
F26	7.5A	EPS KL15
F27	10A	Transmission TCU / PTC / low speed alarm KL15
F28	10A	ADC (camera) / high precision inertial navigation / front millimeter-wave radar KL15
F29	10A	Airbag module KL15
F30	/	Reserved
F31	20A	Transmission TCU / EPP drive motor / IMCU (motor and vehicle control unit) KL30
F32	15A	Third-row left power seat KL15
F33	15A	Third-row right power seat KL15
F34	15A	Power driver seat KL15
F35	10A	ESC/IBOOST/AVM KL15
F36	10A	Nets-within-nets ECU / power amplifier / OMS KL15
F37	/	Reserved
F38	/	Reserved

Code	Specification	Function
F39	20A	IBDU (exterior lamp) KL30 power 4
F40	20A	IBDU (exterior lamp) KL30 power 3
F41	10A	Electric power side load door / lane change assist / high precision inertial navigation / kick sensor KL30
F42	15A	ADC (camera) KL30
F43	10A	PO DCDC / PO BMS / PO motor / CCU (combined charging unit assembly) / EVCC (electric vehicle communication controller) KL30
F44	/	Reserved
F45	7.5A	Wireless charging / door atmosphere light / driver window regulator KL30 power
F46	7.5A	Rearview camera / HUB (video gateway) / rear millimeter-wave radar KL30 power
F47	20A	Front 12V power
F48	20A	Second-row power seat USB KLR
F49	15A	Rear wiper
F50	7.5A	220V inverter / front USB / roof USB KLR
F51	15A	Rear seat 12V power
F52	/	Reserved
F53	7.5A	Rear side USB / second-row right seat USB / window regulator switch KLR
MIDI	125A	ICE (driver compartment fuse box) KL30

Emergency Troubleshooting

Code	Specification	Function
K1	/	Front wiper high-low speed relay
K2	/	Front wiper control relay
K3	/	Reserved
K4	/	IG relay
K5	/	Power-saving relay
K6	/	Reserved
K7	/	Reserved
K8	/	Reserved
K9	/	Main relay
K10	/	Reserved
K11	/	Reserved
K12	/	Reserved
K13	/	ACC relay

Battery fuse box

The battery fuse box is located on the battery positive terminal.

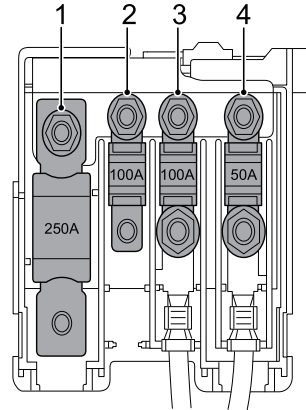
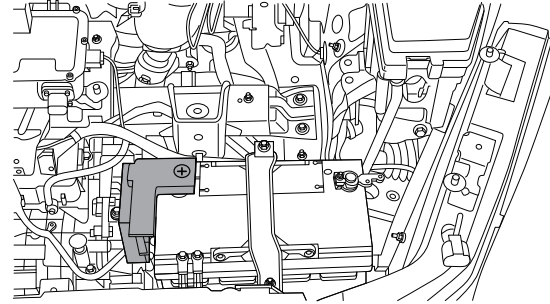

Emergency Troubleshooting

Specification

Code	Specification	Function
1	250A	Front compartment fuse box KL30 power
2	100A	EPS KL30 power
3	100A	Rear PTC heating KL30 power
4	50A	Cooling fan KL30 power

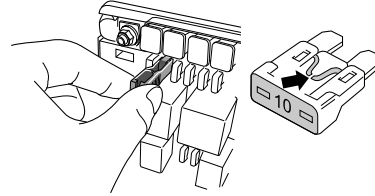

Fuse replacement

! Only replace with fuses of the same specifications/rated current. Installing nonspecific fuse will damage electrical system and even cause fire. Before attempting to replace the fuse, the vehicle power and all electrical devices must be turned off. Any unauthorized change to vehicle electrical system will cause serious adverse effect and fire on the electronic management system.

Pull the fuse outward with puller provided in fuse box to remove the fuse. Internal wiring of the fuse can be used to identify blown fuse (arrowed).

Note: *Repeated failure with the same fuse is the indication of circuit failure. Please contact our authorized service provider as soon as possible.*

Caution

Unauthorized change to electrical system of the vehicle will invalidate the warranty.

3

Maintenance and Service

236 Regular maintenance

236 Owner's check

237 Engine hood

239 Engine compartment

239 Coolant

241 Brake fluid

242 Washer fluid

243 Wiper blades

245 Seat belts

246 Battery

249 High voltage battery pack

251 Tires

253 Other maintenance

Maintenance and Service

Regular maintenance

Regular maintenance is the key to economy, safety and reliability for your vehicle and it must be remembered that the responsibility for maintaining your vehicle in a safe, roadworthy condition rests ultimately on you, the owner/operator.

Necessary maintenance and the intervals have been specified to maintain your vehicle properly. Regular vehicle maintenance shall be done by Our Service Dealer in accordance with Warranty & Service Handbook.

It is in your best interest to have your vehicle regularly maintained in accordance with regulations.

Our Service Dealers are recommended as they have qualified personnel, required facilities and can offer the unique pre-planned service which will give maximum vehicle reliability.

Owner's check

The following are a few simple but important checks which you shall make at regular intervals before driving to ensure reliable and economic operation:

Daily checks

- The lighting (make sure all lens are clean), horn, instrument cluster, warning lights and indicators, wipers and washers are functioning.
- The seat belts are intact.
- The brakes operates normally.
- Visually check for signs of water, fluids, exhaust and other leaks under the vehicle.

Weekly checks or check before a long journey

- Check fluid level/refill.
 - Coolant
 - Windshield washer fluid
 - Brake fluid
- Check for condition and pressure of all tires (including the spare tire).
- Check and operate A/C system.

Maintenance and Service

Harsh conditions

For vehicles often used in harsh conditions, it is recommended to shorten the maintenance interval.

Regular vehicle maintenance shall be done by our authorized service provider in accordance with Warranty & Service Handbook.

Engine hood

Open front compartment hood

In the direction as shown in the figure, pull up twice the unlock handle of front compartment hood below the instrument desk on the driver side to unlock the front compartment, and lift the front compartment hood.

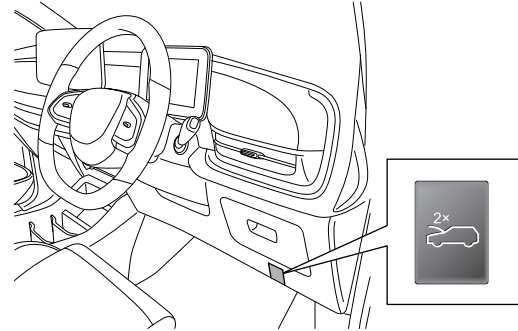

Close front compartment hood

Hold the front compartment hood with both hands and then lower it. When the front compartment hood is lowered about 20 -30 cm away from its locking position, apply a certain downward force to close it with certain acceleration.

After closing the front compartment hood, check if it is completely locked by trying to lift its front edge. If the front compartment hood is not completely locked, please open it again and repeat the closing action.

Caution

Before closing, check that there is no tools, rags, equipment, etc. left in the area under the engine hood.

Front compartment hood unclosed alarm

If the front compartment hood has not been locked completely, the corresponding alarm icon will be displayed on the screen. If the front compartment hood is found not locked completely when the vehicle is running, then warning tones will be sounded together.

Caution

- For safety reasons, the front compartment hood must be closed tightly before driving. Therefore, it is required to check if the latch has been inserted into the lock after closing the front compartment hood, that is, to check if the front compartment hood is aligned with the body parts.
- During driving, if the front compartment hood is found not closed completely, please pull over in a safe condition, and get off to close the front compartment hood before resuming the driving.
- Mind your hand when closing the front compartment hood downward with force.

Engine compartment

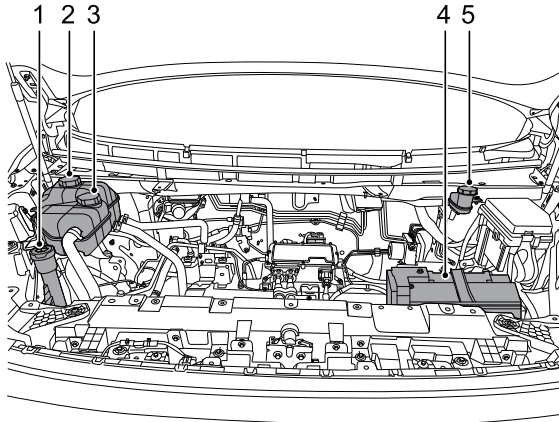

- 1 Washer fluid reservoir
- 2 Battery circulation coolant reservoir
- 3 Electric drive system coolant reservoir
- 4 Battery
- 5 Brake fluid reservoir

Coolant

! Coolant is harmful if swallowed. Do not allow coolant to contact the eyes or skin. If it does, rinse immediately with plenty of water.

Please add correct specification coolant. Never driving the vehicle if coolant of correct specification is not filled. Coolant specification see “Recommended fluid oil”.

At specified intervals the cooling system shall be drained, flushed and refilled with the correct amount of coolant.

Caution

When refilling or replacing coolant, only the specified coolant can be used. The use of non-recommended coolant could cause damage to the cooling system and may invalidate the warranty.

Maintenance and Service

Check and refill

! Do not remove the expansion tank cap while the cooling system is hot, for overflowed water vapor or hot coolant may cause personal injury. If coolant has to be charged when the system is hot, wait for 10 minutes, place a thick cloth over the filler cap and turn the cap slowly anti-clockwise to release the pressure in the expansion tank before removing the cap.

Always check the coolant level with the vehicle on level ground and the coolant system stationary (cold condition).

The level is visible in coolant expansion tank and normal level shall be between 'MAX' and 'MIN' marks.

If the level drops to 'MIN' mark, clean area around the coolant expansion tank cap and then turn anti-clockwise to remove it. Top-up with the specified fluid between 'MAX' and 'MIN' marks. Install the expansion tank cap.

Note: *The coolant may expand when it becomes hot, so the liquid level may be higher than the level mark.*

Caution

If the level has fallen appreciably, or topping-up is required frequently, suspect leakage or overheating and contact our authorized service provider for inspection.

Battery circulation coolant reservoir

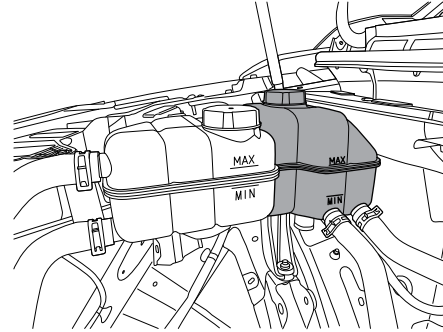

Electric drive system coolant reservoir

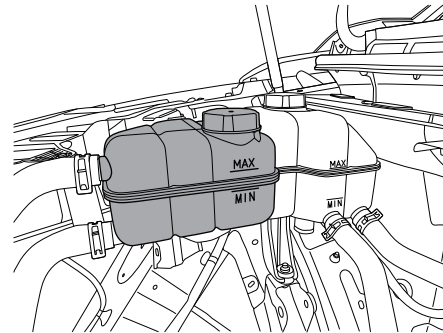

Precautions for cold weather

In order to reduce possible problems which may occur in cold weather, please consider the following suggestions:

- Since the standard freezing point of the coolant used in the vehicle is -35°C (with the mixture ratio of coolant stock solution and water of 1:1), it is necessary to park the vehicle in areas where the coolant temperature can be maintained above -35°C .
- If you are using your vehicle in extremely cold areas where the ambient temperature is below -35°C , please use the coolant of appropriate proportion based on the local temperature. (Refractometer T10007 can be used to detect the freezing point of the coolant)

Brake fluid



If there is a significant drop in the level of the brake fluid, contact our authorized service provider for service as soon as possible.

Use only new brake fluid of the specified type. Use of brake fluid which is old or not the specified type can cause loss of braking performance.

Brake fluid cleanliness is essential. Any dirt entering the system can cause loss of braking performance.

Do not allow brake fluid to contact your skin or eyes; If it does, rinse immediately with plenty of water. Keep brake fluid out of the reach of children.

Caution

- Only refill the brake master cylinder with brake fluid complying with specification DOT4. Do not use brake fluid of any other type.
- Brake fluid will damage the paintwork when coming in contact with it. Wipe it clean immediately and rinse with water.

Maintenance and Service

Check and refill

Be sure to check the brake fluid level after the vehicle is parked on a flat ground and the brake system is in cold state. The “MAX” level mark is on the small reservoir, the “MIN” level mark is on the reservoir of the vacuum booster, and the normal level shall be between ‘MAX’ and ‘MIN’ marks. If the level drops to ‘MIN’ mark, clean area around the filler cap and then turn anti-clockwise to remove it. Fill up specified new brake fluid between ‘MAX’ and ‘MIN’ marks and install the reservoir cap.

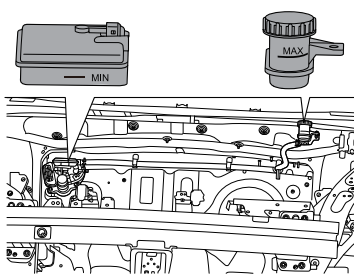

If the level falls below ‘MIN’ mark, “brake system warning light (red)” on information cluster will light on. This indicates fault in the braking system which must be investigated immediately. If in driving, IMMEDIATELY bring the vehicle carefully to a halt. Contact our authorized service provider for service as soon as possible. Do NOT continue driving.



Never discard used brake fluid casually to avoid the environment pollution.

Washer fluid

Check and refill



Driving with a non-operational washer system can be dangerous; always check it before driving. When refilling the washer fluid, do not let it splash onto the paint surface of body. If the washer fluid splashes onto hands or other parts of human body, immediately wash it clean with clear water.

Washer fluid is used to clean the windshield. Check the level of the water fluid on a weekly basis. When the level is too low, please refill the washer fluid. To refill the washer fluid, please open the front compartment hood, open the washer fluid reservoir lid, and then close the lid tightly after refill. For washer fluid specification please see “Recommended fluid oil” in General Technical Parameters section.

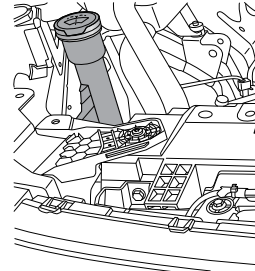

Maintenance and Service

Caution

- Do not use antifreeze or vinegar/aqueous solution in reservoir - Antifreeze can damage paint surfaces and vinegar can damage washer pump. Use the washer fluid recommended and approved by our company. The improper use of washer fluid in winter may cause freezing and damage the washer pump.
- Turning on the washer switch without washer fluid will damage the washer pump.
- When the windshield is dry without washer fluid, turning on the wiper will damage the windshield and the wiper blades. Please spray the washer fluid and turn on the wiper when the washer fluid is sufficient.

Washer nozzle

Check if the washer nozzle is clean and the direction is correct with the washer regularly. If the nozzle is blocked, insert a needle or thin wire into the hole to clear the blockage.

Wiper blades

Inspection

Examine the edge of the blade for roughness or damage, and check that the blade rubber is secure throughout its length.

Note: *Traces of grease and other impurities on the rubber can prevent the wipers from working correctly, and can also damage the windshield.*

Replacement of front windshield wiper blade

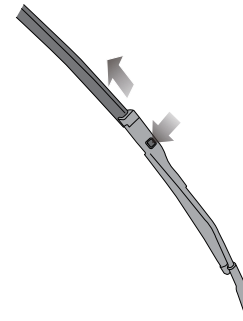

Adjust the front wiper switch to the maintenance function before replacing the front wiper blade.

Within 10 seconds after the vehicle is powered off, move the front wiper switch from OFF position to high speed HI position, and return it to the OFF position, to enable the front wiper blade

Maintenance and Service

move to the highest point (maintenance position), lift the wiper arm from the windshield to keep the blade and arm at an angle of 15°, then replace the blade. The steps as follows:

- 1 Press the button of the wiper arm, and pull the upper end of the blade outward, to separate it from the wiper arm.
- 2 Remove the blade from the wiper arm, and scrap the blade.
- 3 Put the connector of the new wiper into the slot of the wiper arm.
- 4 Push the blade toward the wiper arm until the wiper is fully inserted, to ensure the wiper is fixed on the wiper arm properly.
- 5 Place the wiper assembly back on the windshield.

Caution

Within a ignition cycle (vehicle powered off → vehicle powered on or started → vehicle powered off), use the front wiper maintenance function only once.

Replacement of rear windshield wiper blade

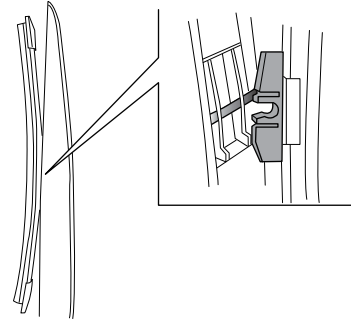

- 1 Lift the wiper arm to a position away from the windshield.
- 2 Slightly pull the blade connection outward to separate it from the wiper arm, and scrap the blade.
- 3 Insert the connector of the new wiper into the slot of the wiper arm.
- 4 Place the wiper assembly back on the windshield.

Maintenance and service

Wash with high-quality cleaner or neutral detergent and wipe it clean with a dry, soft cloth that is free of lint.

Seat belts

Inspection



The belts also have a sensitive retractor which is designed to lock only during heavy acceleration, deceleration or sharp turns.

Do not test the locking device by deliberately jerking forward your upper body.

Check ALL seat belts as follows:

- Check all belt anchorage points for safety.
- Insert the locking tab into the buckle, and check whether the locking operation is clear. Push the red button and check if the locking tab pops neatly.
- With the seat belt half loosened, hold the locking tab and abruptly pull it. Check if the safety mechanism can be locked automatically and prevent further looseness.

Maintenance and service



Do not attempt to repair the retractor or buckle mechanisms, or to modify the seat belts in any way. Seat belts subjected to strain as a result of an accident shall be replaced, and the anchorage points checked, by our authorized service provider.

Regularly inspect the belt webbing for signs of abrasion or wear, paying particular attention to the anchorage points and adjusters.

Clean the seat belt with a sponge dipped with warm water and mild soap; it can be naturally dried, and must not be dried by direct heating or exposure under sunlight. Do not allow water to penetrate into the retractor. Never bleach or dye a seat belt as its strength may be reduced.

Battery

Warnings and instructions for battery:



Wear goggles!



The battery acid is strongly corrosive. Ensure to wear protective gloves and goggles!



Open fires, electric sparks, strong lights and smoking are strictly prohibited!



Explosive gas mixture may be generated during battery recharging!



Ensure to keep any child away from the acid and the battery!



There may be risks of injury, corrosion, accident and fire during operations on the battery and any electrical appliance in the vehicle!

Ensure to wear goggles. Do not allow acid or leaded particles to get into your eyes or onto your skin or clothes.

The acid in the battery is highly corrosive. Ensure to wear protective gloves and goggles. The battery cannot be turned over, or acid may flow out of the vent. If acid gets into your eyes, immediately rinse with clean water for a few minutes, then see a doctor



immediately. If acid splashes onto your skin or clothes, immediately neutralize it with thick soap solution, and then rinse with plenty of water. If you drink acid by mistake, see a doctor immediately.

Open fires, electric sparks, strong lights and smoking are prohibited. When working on cables and electrical appliances and removing electrostatic loads, avoid the generation of electrical sparks. The electrodes of battery can **NEVER** be short-circuited, or it may cause personal injury due to large energy sparks.

Explosive gas mixture may be generated during battery recharging. The gas vent of battery should be kept unblocked to discharge the gas correctly. During recharging, the battery should be located in a space with good ventilation.

Ensure to keep any child away from the acid and the battery.

Turn off the motor, vehicle power supply and all electrical appliances before working on electrical appliances. Remove the negative cable of battery. When replacing bulbs, only the lights are required to be turned off.

Pay attention to the polarities of power supply. Before powering on, the matches of polarities must be checked.



The duration of each powering on should not be less than 5 seconds. Try to avoid powering on and off too frequently.

When removing the battery, please remove the negative cable before positive cable.

Before powering on the battery again, all electric appliances should be turned off. First connect the positive cable, then the negative one. Never connect the cables incorrectly - risk of fire!

Unauthorized removal and installation of battery is strictly prohibited since such operation may cause severe damage to the battery and fuse box in some cases. Please contact Our Service Dealer.

Do not disconnect the battery when the vehicle is powered on or the motor is running, otherwise it may damage the electrical appliances (electrical components).

To prevent the battery housing from exposing to ultraviolet ray, do not expose the battery under the sunshine.

Duration of storing the vehicle

If the vehicle is to be parked for an extended period of time, the static current electrical appliance (like clock, security devices) will drain the battery, and the battery has to be charged. To avoid

such case, charge the battery or disconnect the battery negative cable during the vehicle parking.

Note: Please pay attention to the warnings & instructions for battery before working on it.

Caution

Ensure to turn off the vehicle power supply during parking, otherwise the parking time can be reduced significantly.

Operating in winter

There are particularly strict requirements on the vehicle battery operation in winter. In addition, the starting power provided by the battery at low temperature is only a part of that at normal temperature. Therefore, we recommend to have the vehicle battery checked by Our Service Dealer before the cold season begins, and recharge it if necessary.

If the vehicle is not used for weeks in cold season, please remove the vehicle battery and store in an ice-free room, to prevent it from freezing and damage.

Charging the battery with ground equipment



Do not charge any frozen battery, there is a risk of explosion! Even if the battery has been unfrozen, there may be battery acid spilling out and cause corrosion. Any frozen battery must be replaced.

Maintenance and Service

Turn off the vehicle power supply and all electrical appliances before charging. If the vehicle has been parked for a long period and cannot be started due to lack of power (general terminal voltage \leq 12V), the battery must be removed from the vehicle and charged with a ground equipment (follow the instructions provided by the manufacturer of the charging equipment).

During charging with small current (e.g., a small charging equipment), it is unnecessary to remove the connecting cables of battery. However, please ensure to read the instructions from the manufacturer of the charging equipment.

Before fast charging (i.e., large current charging), both of the connecting cables must be removed.

Note: Please pay attention to the warnings & instructions for battery before working on it. During the charging, the charging equipment can only be powered on after the electrode clamps of charging equipment is connected to the electrodes of battery as required. After the charging is finished, turn off the charging equipment first, remove the power cable, and then remove the electrode clamps of charging equipment from the battery. When charging the external device, the electrodes must be connected accordingly. Do not connect the positive electrode of the battery to the negative electrode of the charging device, and do not connect the electrodes in reverse. Such operation will cause serious damage to the DCDC converter, resulting in failure for vehicle to drive, please contact Our Service Dealer.

Caution

- Keep any child away from the battery, battery acid and charging equipment.
- The battery can only be charged in a space with good ventilation. Smoking is prohibited, and keep away from open fires and electric sparks, as explosive gas mixture may be generated when the battery is charged.
- Protect your eyes and face, never be too close to the battery. If acid splashes onto your eyes or skin, immediately rinse with clean water for several minutes before seeing the doctor.
- The fast charging of the battery is dangerous, which should be done by Our Service Dealer, because it requires professional charging equipment and knowledge.
- Any frozen or unfrozen battery must be replaced. Because cracks may be found on the frozen battery housing. It may cause leak of battery acid and damage to the vehicle.

Removing the battery

Turn off the vehicle power supply and all electrical appliances before the battery removal. To remove the battery, firstly remove the negative cable and then the positive cable. And then remove the bolt on the mounting bracket of battery to remove the battery.

Replacing the battery

The battery installed on your vehicle is designed for the corresponding mounting location. To replace the battery, please

ensure to use one with the same voltage (12V), structure and safety label. The current strength and capacity should be same with the original battery. Our Service Dealer can offer you with genuine batteries.

When installing the battery, please ensure that the vehicle power supply is turned off and all electric appliances are turned off.



Concerning the disposal of used battery, it is suggested to have the battery replaced by Our Service Dealer. Additionally, the battery can never be treated as household garbage because it contains sulfuric acid and lead.

Installing the battery

Before installing the battery, turn off the vehicle power supply and all electrical appliances. Put the battery in the installation position prepared for it, and fix it with the battery bracket. When connecting the battery, please fix the positive cable before the negative cable.

Caution

To prevent the battery from discharging, please turn off the vehicle power supply when you leave the vehicle.

High voltage battery pack

Instructions and restricted conditions

⚠ According to the characteristics of the lithium battery, the vehicle must be charged and discharged every 30 days in storage period, a long time parking easily results in damage of battery, thereby affects the running of whole vehicle. Failure to do so may result in loss or damage of the power battery, may affect your enjoyment of the free warranty!

The electric vehicle model is different from the conventional vehicle, therefore it has particularity on aspects of operation, storage and maintenance, and now some cautions are informed to you.

1 The vehicle cannot be parked for over 8 hours in a place where temperature is over 60°C. The vehicle cannot be parked for over 20 hours in a place where temperature is lower than -30°C. The vehicle cannot be consecutively stored for over 15 days in a environment where temperature is higher than 45°C. If it exceeds maximum limit of the storage environment of vehicle, it will directly affect performance of vehicle and lifetime of high voltage battery pack.

Vehicle cannot be parked in high-temperature places.

2 To better extend the life of the high voltage battery pack, it is recommended to charge the vehicle by slow charging as far as possible.

Maintenance and Service

- 3 When the heating system of A/C is used, it will significantly reduce the vehicle driving range, when cooling is used, it will insignificantly reduce the vehicle driving range. Deep discharging may reduce the battery life, and shallow charging and discharging may extend the battery life. In a low temperature environment, it may significantly reduce the vehicle driving range, and in a high temperature environment, it may not affect the vehicle driving range.
- 4 Vehicle will be kept dry and cannot be placed in damp environment for long time such as parking place with ponding. If the vehicle is immersed in water or waded into the water, it shall be parked in dry place.
- 5 If it is not used for long time (over 3 months), make sure that the vehicle is parked when the high voltage battery pack battery level is about 50%. The vehicle cannot be parked for over 7 days when the high voltage battery pack battery level is lower than 20%.
- 6 Do not disassemble the high voltage battery pack and its components for repair without authorization. Otherwise, the company will not perform the warranty clauses.
- 7 It is recommended to use the vehicle at least once every month. It is recommended to slowly charge the vehicle for more than 10 hours every month to extend the life of the high voltage battery pack.
- 8 The high voltage battery pack is easily damaged at chassis position through scraping and collision. Therefore, you shall timely contact our authorized service provider if the vehicle has driven on abnormal pavement to check whether the high voltage battery pack has deformation or not and whether enclosure has crack or not.
- 9 If the vehicle encounters collision and scraping in the utilization process, the vehicle will be timely checked by our authorized service provider to confirm whether the high voltage battery pack has deformation or not and whether the enclosure has crack or not; if serious accident occurs, after accident has been disposed, you shall contact our authorized service provider to transfer the vehicle to our authorized service provider for check.
- 10 After a serious vehicle accident, personnel in the vehicle need leave the vehicle as soon as possible and contact our authorized service provider for disposal at once.
- 11 If the vehicle body need be repaired or painted due to damaged in an accident, you must contact our authorized service provider to avoid manual damage or fire disaster of high voltage battery pack and relevant operation can be conducted after dismantling the high voltage battery pack.
- 12 Operate the vehicle under full charging for first use.

Tires

! DEFECTIVE TIRES ARE DANGEROUS! Do NOT drive your vehicle if any tire is excessively worn, damaged or inflated to an incorrect pressure.

Frequently inspect the tires and sidewalls for any sign of distortion (bulges), cuts or wear. Gravels and other sharp objects should be removed with a suitable blunt tool. If neglected, they may work through the tire.

Tire pressure

! Driving with incorrectly inflated tires can affect vehicle stability, increase rolling resistance, and cause rapid tire wear and possible permanent damage to the cords of the tire casing.

Remember tire wear and inflation pressure regulations. It is the driver's responsibility to ensure that the tires meet these requirements.

Please check the tire pressure weekly, and adjust the tire pressure according to the requirements on the tire pressure identification at the front lower part of vehicle B-pillar. This Handbook introduces the correct tire pressure in cold condition, see "Wheel and tire" in General Technical Parameters section.

Pressure should be checked with an accurate Tire Pressure Gauge when the tire is cold instead of decreasing the value

under warm condition as the pressure will be higher than normal pressure due to temperature. Be sure to install the valve caps to prevent dirt entry into the valve mechanism.

A natural pressure loss will occur with time; any unusual pressure loss should be investigated and rectified.

Note: Specified pressure applies to a cold tire, while the pressure of hot tire should be higher.

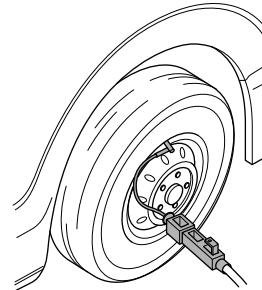

Wear indicator

There are wear indicators in the tread of all original tires. When the tire has worn down until 1.6 mm of the tread is remaining the wear indicators will appear across the full width of the tread pattern.

A tire should be replaced immediately where any part of the wear indicator becomes visible. However it is in your interest to note that tire safety and performance tends to reduce before the legal limit is reached. For example, badly worn tires will increase the risk of aquaplaning.

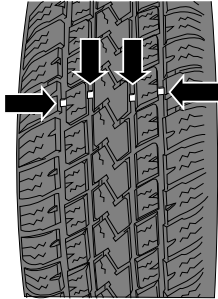

Tire check and rotation

In order to achieve even tire wear, it is recommended to check the tires every 5,000km. If irregular wear is found, the tires shall be rotated. During the tire rotation, check the tires for correct dynamic balance.

During the tire rotation, check for uneven wear and damage. Abnormal wear is usually caused by incorrect tire pressure, poor wheel alignment, poor wheel dynamic balance, emergency braking or cornering. Check the tread or the side of the tire for collision damage or bulges. If one of these conditions is found, the tire shall be replaced. If fabric or cord is visible, the tire shall also be replaced. After the tire rotation, adjust the inflation pressure of the front and rear tires as shown on the tire pressure label on the vehicle and check the tightness of the wheel nuts.

Tire rotation method

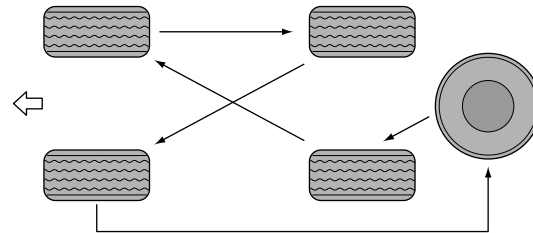

Other maintenance

Vehicle wash



When driving for the first time after washing the vehicle, gently depress the brake pedal several times to remove moisture from the brake discs.

Carefully wash the tires. Never use a high pressure nozzle as it may damage tires. If any damage is found, replace the tire.

Water flushing is prohibited in the front part of the interior (near the dashboard area) to avoid unnecessary damage to related parts.

Do not flush the front compartment, battery compartment and peripheral inserts with water.

Careful attention to the following will help to retain the value of your vehicle:

- Clean the vehicle with cold or lukewarm water. Hot water may cause damage to vehicle paintwork under extreme cold conditions.
- No vehicle washing under strong direct sunlight during hot weather.
- Use special vehicle cleaner to remove grease and tar spots on vehicle body and while still wet, wash the paintwork using a soft sponge and generous quantities of water containing car shampoo. Rinse thoroughly and dry off with a chamois leather.

- When cleaning the vehicle with a hose, it is prohibited to spray the water directly to the window, the door, or the brake parts through the gap of the wheel.
- After cleaning, inspect the paintwork for damage and stone chips; apply touch-up paint if necessary. Use polishing wax to protect the paintwork from time to time.
- When using high pressure cleaning equipments, the water jet shall be kept moving. Do not direct it at the door gaps, seals, electrical components or their connections.

Note: Please timely remove the substances on the surface of the paint which seem harmless but in fact corrosive, such as bird droppings, resin, insect wreckage, tar spots, road salt and industrial dust. Otherwise permanent staining or damage will be produced.

Maintenance and Service

Anti-corrosion of underbody

The underbody of your vehicle has been treated with anticorrosion. Check underbody anti-corrosion regularly.

Use a water jet to remove accumulations of caked mud or debris on underbody. Especially in winter, when salt is used on icy and snowy roads.

Seat and trim

Often use vacuum sweeper or soft brush to clean dirt and dust accumulated on fibers. Often use clean cloth to wipe the trim. Use special cleaner to remove general trim dust, staining or spots. Use special cleaner to clean leather parts.

Door seals

To prevent rubber door seals from freezing in a cold weather, a rubber maintenance product or a silicone spray shall be used for its protection.

Window glass

Often use glass cleaner to clean window glass.

Use high-quality cleaner or neutral detergent rather than abrasives or chemical solvents to wash.

General Technical Parameters

256 Major vehicle dimension parameters

257 Vehicle weight parameters

258 Dynamic performance parameters

259 Main parameters of drive motor

260 Chassis technical parameters

261 Recommended fluids

262 Wheels and tires

263 Wheel alignment parameters

General Technical Parameters

Major vehicle dimension parameters

Model	EPX1A-1200
Drive mode	Front-motor, front-wheel-drive
Length, mm	5270
Width, mm	2000
Height, mm	1840
Wheelbase, mm	3200
Front/Rear suspension, mm	955/1115
Front/rear track, mm	1690/1712
	1700/1722
Minimum turning circle diameter, m	12.7±1

General Technical Parameters

Vehicle weight parameters

Model	EPX1A-1200		
Maximum allowable total mass, kg	3095	3095	3000
Curb weight, kg	2535	2410	2310
Axle load (front/rear axle load under gross vehicle weight), kg	1415/1680	1415/1680	1335/1665
Number of seats	7, 8	7, 8	7, 8

General Technical Parameters

Dynamic performance parameters

Item	Parameters		
Maximum allowable total mass, kg	3095	3095	3000
Curb weight, kg	2535	2410	2310
Maximum design speed, km/h	180	180	180
Maximum gradeability, %	30	30	30
Accelerating ability (Accelerating time from 0 to 100 km/h), second	8.9	8.9	8.9
Driving range (WLTP condition), km	430	435	440

General Technical Parameters

Main parameters of drive motor

Model	TZ204XS1351
Type	Permanent magnet synchronous motor
Rated power, kw	90
Rated speed, r/min	6000
Rated torque, Nm	120
Peak power, kw	180
Peak speed, r/min	17000
Peak torque, Nm	350
Working voltage of motor, V	302.4 ~ 469.8

General Technical Parameters

Chassis technical parameters

Item	Parameters
Front suspension	McPherson independent suspension
Rear suspension	Multi-link independent suspension
Requirements for steel wheel dynamic balance	Residual dynamic unbalance on both sides of steel wheel assembly is less than 10g
Requirements for aluminum wheel dynamic balance	Residual dynamic unbalance on both sides of aluminum wheel assembly is less than 8g
Reasonable free travel range of brake pedal	Within 10mm
Reasonable application range of brake friction pair	At least 2mm remaining before wearable material reaching its wear limit

General Technical Parameters

Recommended fluids

Item	Grade	Capacity
Battery circulation coolant, L	D-35 (-35°C)	4.5
Electric drive system coolant, L	D-35 (-35°C)	4.8
Brake fluid, L	Laike 901-4 DOT 4	0.87
Washer fluid, L	Universal low freezing point washer fluid	3
Air conditioning refrigerant, g	R1234yf	850 1000(It applies to vehicles configured with heat pump)
Reducer lubricating fluid, L	Shell SL2808	0.75±0.05

General Technical Parameters

Wheels and tires

Item			Parameters	
Wheel specification			6.5Jx18	7.5Jx19
Tire specifications			225/60R18	235/55R19
Tire Pressure (cold state)	Front wheel	Half load	260kPa/2.6bar/38psi	260kPa/2.6bar/38psi
		Full load	280kPa/2.8bar/41psi	280kPa/2.8bar/41psi
	Rear wheel	Half load	260kPa/2.6bar/38psi	260kPa/2.6bar/38psi
		Full load	280kPa/2.8bar/41psi	280kPa/2.8bar/41psi

General Technical Parameters

Wheel alignment parameters

Item		Parameters
Front suspension	Toe-in (single side)	$0.1^{\circ} \pm 0.10^{\circ}$
	Camber	$-0.70^{\circ} \pm 0.75^{\circ}$ Difference between left and right $\leq 0.75^{\circ}$
	Kingpin inclination angle	12.34°
	Kingpin caster angle	$4.82^{\circ} \pm 0.75^{\circ}$ Difference between left and right $\leq 0.75^{\circ}$
Rear suspension	Toe-in (single side)	$0.17^{\circ} \pm 0.08^{\circ}$
	Camber	$-0.83^{\circ} \pm 0.57^{\circ}$ Difference between left and right $\leq 0.75^{\circ}$
	Thrust angle	$0^{\circ} \pm 0.075^{\circ}$